

Operation Manual

Embroidery Machine

Product Code: 888-G60/G70/G72

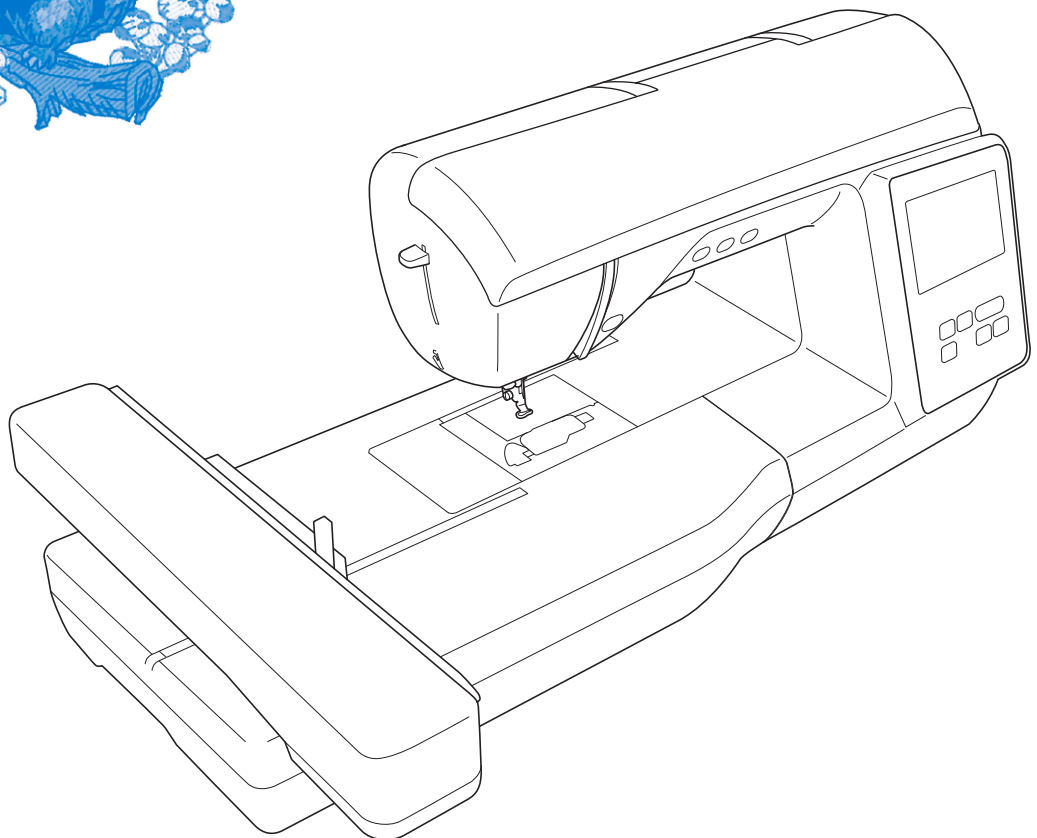

Be sure to read this document before using the machine.
We recommend that you keep this document nearby for future reference.

INTRODUCTION

Thank you for purchasing this machine. Before using this machine, carefully read the "IMPORTANT SAFETY INSTRUCTIONS", and then study this manual for the correct operation of the various functions.

In addition, after you have finished reading this manual, store it where it can quickly be accessed for future reference.

IMPORTANT SAFETY INSTRUCTIONS

Please read these safety instructions before attempting to use the machine.

DANGER

- To reduce the risk of electrical shock

1 Always unplug the machine from the electrical outlet immediately after using, when cleaning, making any user servicing adjustments mentioned in this manual, or if you are leaving the machine unattended.

WARNING

- To reduce the risk of burns, fire, electrical shock, or injury to persons.

2 Always unplug the machine from the electrical outlet when making any adjustments mentioned in the instruction manual.

- To unplug the machine, switch the machine to the symbol "O" position to turn it off, then grasp the plug and pull it out of the electrical outlet. Do not pull on the cord.
- Plug the machine directly into the electrical outlet. Do not use an extension cord.
- Always unplug your machine if there is a power failure.

3 Electrical Hazards:

- This machine should be connected to an AC power source within the range indicated on the rating label. Do not connect it to a DC power source or inverter. If you are not sure what kind of power source you have, contact a qualified electrician.
- This machine is approved for use in the country of purchase only.

4 Never operate this machine if it has a damaged cord or plug, if it is not working properly, has been dropped or damaged, or water is spilled on the unit. Return the machine to the nearest authorized Brother dealer for examination, repair, electrical or mechanical adjustment.

- While the machine is stored or in use if you notice anything unusual, such as an odor, heat, discoloration or deformation, stop using the machine immediately and unplug the power cord.
- When transporting the machine, be sure to carry it by its handle. Lifting the machine by any other part may damage the machine or result in the machine falling, which could cause injuries.
- When lifting the machine, be careful not to make any sudden or careless movements, which may cause a personal injury.

5 Always keep your work area clear:

- Never operate the machine with any air openings blocked. Keep ventilation openings of the machine free from the build up of lint, dust, and loose cloth.
- Never drop or insert foreign objects in any opening.
- Do not operate where aerosol (spray) products are being used or where oxygen is being administered.
- Do not use the machine near a heat source, such as a stove or iron; otherwise, the machine, power cord or garment being embroidered may ignite, resulting in fire or an electric shock.
- Do not place this machine on an unstable surface, such as an unsteady or slanted table, otherwise the machine may fall, resulting in injuries.

6 Special care is required when embroidering:

- Always pay close attention to the needle. Do not use bent or damaged needles.
- Keep fingers away from all moving parts. Special care is required around the machine needle.

- Switch the machine to the symbol “O” position to turn it off when making any adjustments in the needle area.
- Do not use a damaged or incorrect needle plate, as it could cause the needle to break.

7 This machine is not a toy:

- Your close attention is necessary when the machine is used by or near children.
- The plastic bag that this machine was supplied in should be kept out of the reach of children or disposed of. Never allow children to play with the bag due to the danger of suffocation.
- Do not use outdoors.

8 For a longer service life:

- When using and storing this machine, avoid direct sunlight and high humidity locations. Do not use or store the machine near a space heater, iron, halogen lamp, or other hot objects.
- Do not use cleansers or organic solvents, such as thinner, petroleum ether or alcohol, to clean the machine. Otherwise, the finish may peel off or become scratched.
- Always consult the Operation Manual when replacing or installing any assemblies, the presser feet, needle or other parts to assure correct installation.

9 For repair or adjustment:

- If the light unit is damaged, it must be replaced by an authorized Brother dealer.
- In the event a malfunction occurs or adjustment is required, first follow the troubleshooting table in the back of the Operation Manual to inspect and adjust the machine yourself. If the problem persists, please consult your local authorized Brother dealer.

Use this machine only for its intended use as described in the manual.

Use accessories recommended by the manufacturer as contained in this manual.

The contents of this manual and specifications of this product are subject to change without notice.

For additional product information and updates, visit our website at www.brother.com

SAVE THESE INSTRUCTIONS

This machine is intended for household use.

FOR USERS IN COUNTRIES EXCEPT CENELEC COUNTRIES

This appliance is not intended for use by persons (including children) with reduced physical, sensory or mental capabilities, or lack of experience and knowledge, unless they have been given supervision or instruction concerning use of the appliance by a person responsible for their safety. Children should be supervised to ensure that they do not play with the appliance.

FOR USERS IN CENELEC COUNTRIES

This appliance can be used by children aged from 8 years and above and persons with reduced physical, sensory or mental capabilities or lack of experience and knowledge if they have been given supervision or instruction concerning use of the appliance in a safe way and understand the hazards involved. Children shall not play with the appliance. Cleaning and user maintenance shall not be made by children without supervision.

FOR USERS IN THE UK, EIRE, MALTA AND CYPRUS ONLY

IMPORTANT

- In the event of replacing the plug fuse, use a fuse approved by ASTA to BS 1362, i.e. carrying the  mark, rating as marked on plug.
- Always replace the fuse cover. Never use plugs with the fuse cover omitted.
- If the available electrical outlet is not suitable for the plug supplied with this equipment, you should contact your authorized Brother dealer to obtain the correct lead.

Federal Communications Commission (FCC) Supplier's Declaration of Conformity (For U.S.A. Only)

Responsible Party: Brother International Corporation
200 Crossing Boulevard
P.O. Box 6911
Bridgewater, NJ 08807-0911
USA
TEL : (908) 704-1700

declares that the product

Product Name: Brother Embroidery Machine
Model Number: NQ1700E

This device complies with Part 15 of the FCC Rules. Operation is subject to the following two conditions: (1) this device may not cause harmful interference, and (2) this device must accept any interference received, including interference that may cause undesired operation.

This equipment has been tested and found to comply with the limits for a Class B digital device, pursuant to Part 15 of the FCC Rules. These limits are designed to provide reasonable protection against harmful interference in a residential installation. This equipment generates, uses, and can radiate radio frequency energy and, if not installed and used in accordance with the instructions, may cause harmful interference to radio communications. However, there is no guarantee that interference will not occur in a particular installation. If this equipment does cause harmful interference to radio

or television reception, which can be determined by turning the equipment off and on, the user is encouraged to try to correct the interference by one or more of the following measures:

- Reorient or relocate the receiving antenna.
- Increase the separation between the equipment and receiver.
- Connect the equipment into an outlet on a circuit different from that to which the receiver is connected.
- Consult the authorized Brother dealer or an experienced radio/TV technician for help.
- This transmitter must not be co-located or operated in conjunction with any other antenna or transmitter.

Important

Changes or modifications not expressly approved by Brother Industries, Ltd. could void the user's authority to operate the equipment.

This equipment complies with FCC/IC radiation exposure limits set forth for an uncontrolled environment and meets the FCC radio frequency (RF) Exposure Guidelines and RSS-102 of the IC radio frequency (RF) Exposure rules. This equipment should be installed and operated keeping the radiator at least 20cm or more away from person's body.

For Users in Canada

This device complies with Industry Canada's licence-exempt RSSs. Operation is subject to the following two conditions:

- (1) This device may not cause interference; and
- (2) This device must accept any interference, including interference that may cause undesired operation of the device.

This equipment complies with FCC/IC radiation exposure limits set forth for an uncontrolled environment and meets the FCC radio frequency (RF) Exposure Guidelines and RSS-102 of the IC radio frequency (RF) Exposure rules. This equipment should be installed and operated keeping the radiator at least 20cm or more away from person's body.

For Users in Mexico

The operation of this equipment is subject to the following two conditions:

- (1) it is possible that this equipment or device may not cause harmful interference, and
- (2) this equipment or device must accept any interference, including interference that may cause undesired operation.

La operación de este equipo está sujeta a las siguientes dos condiciones:

- (1) es posible que este equipo o dispositivo no cause interferencias perjudiciales y
- (2) este equipo o dispositivo debe aceptar cualquier interferencia, incluyendo la que pueda causar su operación no deseada.

Declaration of Conformity (Europe and Turkey only)

We, Brother Industries, Ltd. 15-1 Naeshiro-cho, Mizuho-ku, Nagoya 467-8561 Japan declare that this product is in conformity with the essential requirements of all relevant directives and regulations applied within the European Community.

The Declaration of Conformity (DoC) can be downloaded from Brother support website. Visit support.brother.com

Declaration of Conformity for RE Directive 2014/53/EU (Europe and Turkey only) (Applicable to models with radio interfaces)

We, Brother Industries, Ltd. 15-1 Naeshiro-cho, Mizuho-ku, Nagoya 467-8561 Japan declare that these products are in conformity with the provisions of the RE Directive 2014/53/EU.

The Declaration of Conformity (DoC) can be downloaded from Brother support website. Visit support.brother.com

Wireless LAN (Models with Wireless LAN function only)

This machine supports wireless interface.

Frequency band(s): 2400-2483.5 MHz

Maximum radio-frequency power transmitted in the frequency band(s): Less than 20 dBm(e.i.r.p)

UK Declaration of Conformity (Great Britain only)

We, Brother Industries Ltd. 15-1 Naeshiro-cho, Mizuho-ku, Nagoya 467-8561 Japan declare that these products are in conformity with the relevant UK legislation.

The Declaration of Conformity (DoC) can be downloaded from Brother support website. Visit support.brother.com

UK Declaration of Conformity for Radio Equipment Regulation 2017

(Great Britain only) (Applicable to models with radio interfaces)

We, Brother Industries Ltd. 15-1 Naeshiro-cho, Mizuho-ku, Nagoya 467-8561 Japan declare that these products are in conformity with the provisions of the Radio Equipment Regulation 2017.

The Declaration of Conformity (DoC) can be downloaded from Brother support website. Visit support.brother.com

For Users in Norway

This subsection does not apply for the geographical area within a radius of 20 km from the centre of Ny-Alesund on Svalbard.

Dette underavsnittet gjelder ikke for det geografiske området innenfor en radius av 20 km fra sentrum av Ny-Ålesund på Svalbard.

For Users in Thailand

This telecommunication equipment conforms to NTC technical requirement.

Terms of Use

IMPORTANT-PLEASE READ CAREFULLY:

This Terms of Use ("Agreement") is a legal agreement between Brother Industries, Ltd. ("Company") and you that governs your use of any Software, installed on or made available by Company for use with sewing or craft products ("Company Product"). The term of "Software" means any and all contents data, design data, data format, firmware of Company Product, and PC application or mobile device application.

By using the Software and Company Product, you shall be deemed to have agreed to be bound by the terms of this Agreement. If you do not agree to the terms of this Agreement, Company is unwilling to license the Software and you are not allowed to use the Software. Amendments and supplements to this Agreement may be attached to the Software.

An individual who accepts this Agreement on behalf of an entity represents to Company that he or she has the legal right to enter into a binding legal agreement for that entity.

Terms and Conditions

1 Grant of License.

- 1.1 Subject to this Agreement, Company hereby grants you a personal, non-exclusive, non-transferable and revocable license to use the Software only within the Company Product.
- 1.2 Your right to use of the Software is licensed and not sold, and solely for your use subject to this Agreement. Company or its suppliers retains all right, title, and interest relating to Software, including without limitation all intellectual property rights relating thereto.

2 Restrictions

- 2.1 Except as expressly set out in this Agreement or as required by any local law, you shall undertake:
 - 2.1.1 not to disassemble, de-compile, reverse engineer, translate or otherwise attempt to learn the source code of the Software (including the data or contents created by using the Company Product or contents editing application software; hereinafter the same shall apply in this Clause 2.);
 - 2.1.2 not to create derivative works based on the whole or any part of the Software;
 - 2.1.3 not to distribute, provide or make available the Software in any form, in whole or in part to any person without prior written consent from Company;
 - 2.1.4 not to copy the Software, except where such copying is incidental to normal use of the Software with Company Product or where it is necessary for the purpose of back-up or operational security;

- 2.1.5 not to transfer, rent, lease, sub-license, loan, translate, merge, adapt, vary, alter or modify, the whole or any part of the Software nor permit the Software or any part of it to be combined with, or become incorporated in, any other programs;
- 2.1.6 to include Company's copyright notice and this Agreement on all entire and partial copies of the Software; and
- 2.1.7 not to use the Software for any purpose (including, but not limited to, use with unauthorized sewing/craft products or software) other than as provided under Clause 1 of this Agreement.

3 No warranty

TO THE EXTENT PERMISSIBLE BY APPLICABLE LAW, THIS SOFTWARE IS PROVIDED TO YOU "AS IS" WITHOUT WARRANTIES OR CONDITIONS OF ANY KIND, WHETHER ORAL OR WRITTEN, EXPRESS OR IMPLIED. COMPANY SPECIFICALLY DISCLAIMS ANY IMPLIED WARRANTIES OR CONDITIONS OF MERCHANTABILITY, SATISFACTORY QUALITY, NON-INFRINGEMENT AND/OR FITNESS FOR A PARTICULAR PURPOSE.

4 Limitation of liability

- 4.1 COMPANY SHALL NOT BE LIABLE TO YOU, ITS END-USERS OR ANY OTHER ENTITY FOR ANY LOSS OF PROFITS OR INCOME OR SAVINGS, LOSS OF DATA, INTERRUPTION OF USE, OR CONSEQUENTIAL, INCIDENTAL, SPECIAL, PUNITIVE OR INDIRECT DAMAGES INCURRED BY SUCH PARTY (WHETHER IN AN ACTION IN CONTRACT OR TORT), EVEN IF COMPANY HAS BEEN ADVISED OF THE POSSIBILITY OF SUCH DAMAGES, ARISING OUT OF OR RELATING TO THE SOFTWARE, SUPPORT SERVICE OR THIS AGREEMENT. THESE LIMITATIONS SHALL APPLY TO THE MAXIMUM EXTENT ALLOWED BY APPLICABLE LAW NOTWITHSTANDING ANY FAILURE OF ESSENTIAL PURPOSE OF ANY LIMITED REMEDY.
- 4.2 NOTWITHSTANDING THE CLAUSE 3 OR 4.1 HEREOF, THIS AGREEMENT DOES NOT PURPORT TO EXCLUDE OR RESTRICT COMPANY'S LIABILITY FOR DEATH OR PERSONAL INJURY RESULTING FROM NEGLIGENCE OR LIMIT THE STATUTORY RIGHTS OF A CONSUMER.

5 Termination

- 5.1 Company shall have the right to terminate this Agreement at any time by providing a written notice to you if you commit a material breach of any terms of this Agreement and fail to immediately rectify such breach upon Company's request.
- 5.2 Upon termination for any reason all rights granted to you under this Agreement shall cease, you shall cease all activities authorized by this Agreement and you shall immediately delete or remove the Software from all computer equipment in your possession and delete or destroy all copies of the Software or its derivative works in your possession. In addition to the above, you shall delete contents or design data created by you from the Company Product in your possession.

6 Miscellaneous terms

- 6.1 You shall not export or re-export the Software or any copy or adaptation thereof in violation of any applicable laws or regulations.
- 6.2 You shall not assign all or any part of this Agreement to any third party or any interest therein, without prior written consent of Company. A change of control or reorganization of you pursuant to a merger, sale of assets or stock shall be deemed to be an assignment under this Agreement.
- 6.3 You agree that a breach of this Agreement will cause irreparable injury to Company for which monetary damages would not be an adequate remedy and Company shall be entitled to seek equitable relief in addition to any remedies it may have hereunder or at law without a bond, other security, or proof of damages.
- 6.4 If any provisions of this Agreement shall be declared or determined as void or unenforceable by a court of competent jurisdiction, such provisions shall be severable and independent from the other provisions of this Agreement and the validity of the other provisions and of the entire Agreement shall not be affected thereby.
- 6.5 This Agreement, together with all exhibits or other attachments referenced herein, constitutes the entire agreement between the parties on the subject matter hereof, and supersedes all proposals, oral and written, between the parties on this subject.
- 6.6 If Company fails to insist that you perform any of your obligations under this Agreement, or if Company does not enforce any rights against you, or if Company delay in doing so, that will not mean that Company have waived any rights against you and will not mean that you do not have to comply with those obligations. If Company does waive a default by you, Company will only do so in writing, and that will not mean that Company will automatically waive any later default by you.

- 6.7 This Agreement is governed by the laws of Japan and Japanese Courts shall have exclusive jurisdiction with respect to this Agreement except with regard to enforcement in which case the jurisdiction of the Japanese Courts shall be non-exclusive.
- 6.8 The Company may update this Agreement in the below cases: A) When the changes are made for the users' benefit, or B) When the updates to the Agreement are adequate, reasonable, and not contrary to the purposes of the Agreement.
The Company will notify you and give you the opportunity to review any material changes or updates to the Agreement, by posting a notice on the Company's website or a website specified by the Company at least 30 days before the Agreement enters into effect. Once the updated Agreement is in effect, you will be bound by it if you continue to use the Software.

OPEN SOURCE LICENSING REMARKS

This product includes open-source software. To see the open source licensing remarks, please go to the manual download section on your model's home page of Brother support website at "<http://s.brother/cphan/>".

TRADEMARKS

WPA™ and WPA2™ are trademarks of Wi-Fi Alliance®.

Any trade names and product names of companies appearing on Brother products, related documents and any other materials are all trademarks or registered trademarks of those respective companies.

COPYRIGHT AND LICENSE

This product includes software developed by the following vendor:
©2008 Devicescape Software, Inc.

PRECAUTION FOR WIRELESS CONNECTION

Make sure you use a router or firewall when connecting your machine to the Internet to protect it against unauthorized access from the Internet.

CONTENTS

Chapter 1 GETTING READY 9

- Names of Machine Parts..... 9**
 - Included accessories 10
- Turning the Machine On/Off..... 11**
- LCD Operation..... 12**
 - Settings screen..... 12
 - Adjusting input sensitivity for operation keys..... 13
- Wireless Network Connection Functions..... 14**
 - Operations available with a wireless network connection 14
 - Enabling a wireless network connection..... 14
 - Using the wizard to set up the wireless network connection 14
- Winding/Installing the Bobbin..... 16**
 - Winding the bobbin 16
 - Installing the bobbin..... 19
- Upper Threading 20**
 - Threading the upper thread 20
- Replacing the Needle..... 23**
 - Checking the needle..... 23
 - Replacing the needle..... 23

Chapter 2 EMBROIDERY 25

- Embroidering Preparation..... 25**
 - Attaching the embroidery unit 25
 - Embroidering attractive finishes..... 27
 - Hooping the fabric in the embroidery frame..... 27
 - Attaching the embroidery frame 29
- Embroidering..... 31**
 - Selecting an embroidery pattern 31
 - Embroidering a pattern 34
 - Embroidery Foot Auto Down 36
 - Adjusting thread tension..... 37
 - Adjusting the bobbin case (with no color on the screw)..... 38
 - Using the automatic thread cutting function (End Color Trim)..... 38
 - Using the Thread Trimming Function (Jump Stitch Trim) 39
 - Embroidering the appliqué patterns 39
 - Using a frame pattern to make an appliqué 40
 - Split embroidery patterns..... 41
- Editing Patterns (Pattern Editing Screen) 42**
- Editing Patterns (Embroidery Settings Screen) 44**
 - Aligning the pattern and the needle position 44
 - Embroidering linked characters 45
 - Thread color sorting 46
- Using the Memory Function 46**
 - Saving embroidery patterns 47
 - Retrieving embroidery patterns..... 47

Chapter 3 APPENDIX 49

- Care and Maintenance..... 49**
 - Cleaning the LCD..... 49
 - Cleaning the machine surface 49
 - Restrictions on oiling..... 49
 - Precautions on storing the machine..... 49
 - Cleaning the race 49
 - Touch panel is malfunctioning 50
 - Replacing the embroidery foot 50
- Troubleshooting..... 51**
 - List of symptoms..... 51
 - Error messages..... 54
 - How can I find the wireless security information (SSID and network key) 56
 - Operation beeps..... 56
- Specifications 57**
- Updating Your Machine’s Software 57**

- Index..... 58**

Chapter 1 GETTING READY

Note

- Be sure to install the latest software. Refer to “Updating Your Machine’s Software” on page 57.

Names of Machine Parts

The appearance may differ depending on the machine model you purchased.

■ Main parts

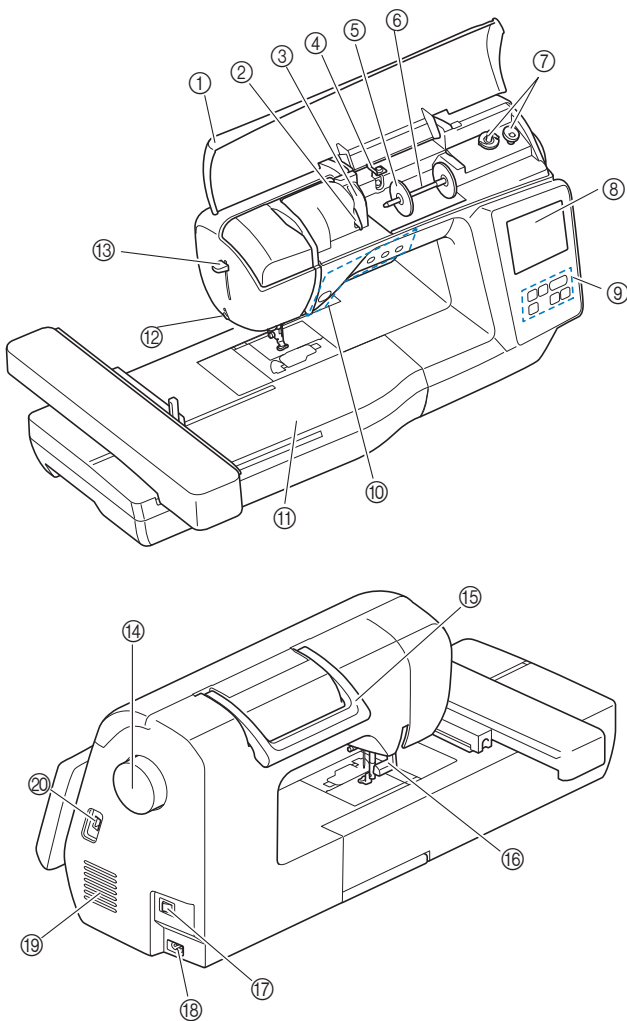

- ① Top cover (page 16)
- ② Thread guide plate (page 17)
- ③ Thread guide cover
- ④ Bobbin winding thread guide and pretension disk (page 18)
- ⑤ Spool cap (page 17)
- ⑥ Spool pin (page 17)
- ⑦ Bobbin winder (page 16)
- ⑧ LCD (liquid crystal display) (page 12)

- ⑨ Operation panel (page 10)
- ⑩ Operation buttons (page 10)
- ⑪ Embroidery unit
- ⑫ Thread cutter (page 22)
- ⑬ Needle threader lever (page 22)
- ⑭ Handwheel
Turn the handwheel toward you (counterclockwise) to raise and lower the needle.
- ⑮ Handle
Carry the machine by its handle when transporting.
- ⑯ Presser foot lever
Raise and lower the presser foot lever to raise and lower the presser foot.
- ⑰ Main power switch (page 11)
- ⑱ Power supply jack (page 11)
- ⑲ Air vent
The air vent allows the air surrounding the motor to circulate. Do not cover the air vent while the machine is being used.
- ⑳ USB port (for a USB flash drive) (page 47)

■ Needle and presser foot section

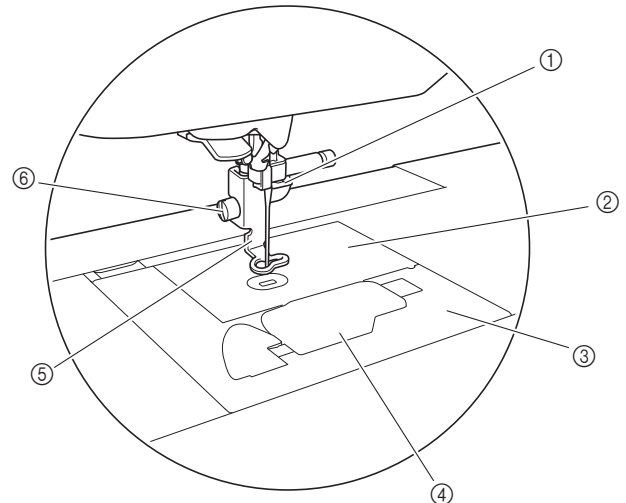

- ① Needle bar thread guide (page 21)
- ② Needle plate
- ③ Needle plate cover (page 19)
- ④ Bobbin cover/bobbin case (page 19, 50)
- ⑤ Embroidery foot (page 34, 50)
The embroidery foot helps control fabric flexibility for better stitch consistency.
- ⑥ Embroidery foot screw (page 51)
Use the embroidery foot screw to hold the embroidery foot in place.

■ Embroidery Unit

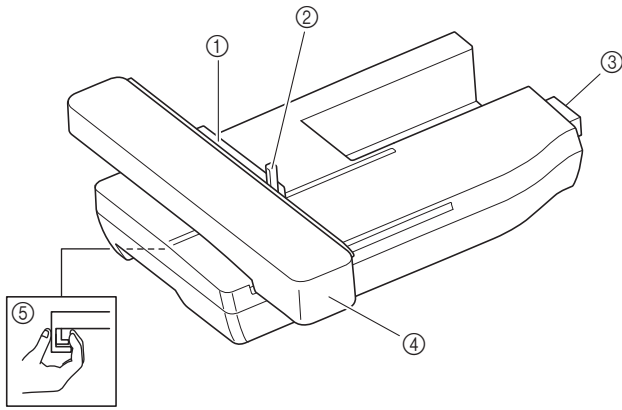

- ① Embroidery frame holder (page 30)
- ② Frame-securing lever (page 29)
- ③ Embroidery unit connection (page 25)
- ④ Carriage (page 25)
- ⑤ Release button (page 26)

■ Operation buttons

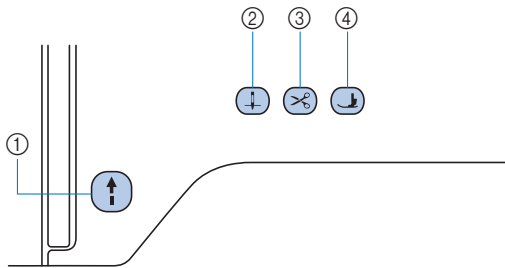

- ① **“Start/Stop” button**

Press the “Start/Stop” button to start or stop embroidering. The button changes color according to the machine’s operation mode.

 - Green: The machine is ready to embroider or is embroidering.
 - Red: The machine cannot embroider.
 - Orange: The machine is winding the bobbin thread, or the bobbin winder shaft is moved to the right side.
- ② **Needle position button**

Press the needle position button to raise or lower the needle.
- ③ **Thread cutter button**

Press the thread cutter button after embroidering is stopped to cut both the upper and the bobbin threads.
- ④ **Presser foot lifter button**

Press this button to lower the presser foot and apply pressure to the fabric. Press this button again to raise the presser foot.

■ Operation panel and operation keys

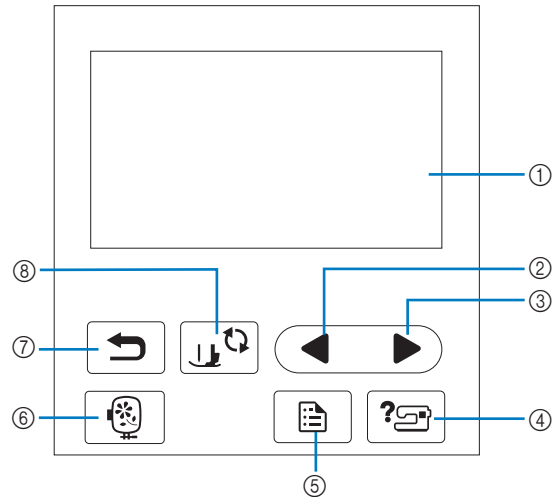

- ① **LCD (liquid crystal display) (touch panel)**

Selected pattern settings and messages are displayed. Touch the keys displayed on the LCD to perform operations. For details, refer to “LCD Operation” on page 12.
- ② **Previous page key**

Displays the previous screen when there are items that are not displayed on the LCD.
- ③ **Next page key**

Displays the next screen when there are items that are not displayed on the LCD.
- ④ **Help key**

Press to get help on using the machine.
- ⑤ **Settings key**

Press to set the needle stop position, the buzzer sound, and more.
- ⑥ **Embroidery key**

Press to display the pattern type selection screen.
- ⑦ **Back key**

Press to return to the previous screen.
- ⑧ **Presser foot/Needle exchange key**

Press before changing the needle, the presser foot, etc. This key locks all key and button functions to prevent operation of the machine.

Note

- The operation keys of this machine are capacitive touch sensors. Operate the keys by directly touching them with your finger. The response of the keys varies according to the user. The pressure exerted on the keys does not affect the response of the keys.
- Since the operation keys react differently depending on the user, adjust the setting for “Adjusting input sensitivity for operation keys” on page 13.
- When using an electrostatic touch pen, make sure that its point is 8 mm or more. Do not use a touch pen with a thin point or a unique shape.

Included accessories

For included accessories of your machine, refer to the additional sheet “Included Accessories”.

Turning the Machine On/Off

⚠ WARNING

- Use only regular household electricity for the power source. Using other power sources may result in fire, electric shock, or damage to the machine.
- Make sure that the plugs on the power cord are firmly inserted into the electrical outlet and the power cord receptacle on the machine. Otherwise, a fire or electric shock may result.
- Do not insert the plug on the power cord into an electrical outlet that is in poor condition.
- Turn the main power to OFF and remove the plug in the following circumstances:
 - When you are away from the machine
 - After using the machine
 - When the power fails during use
 - When the machine does not operate correctly due to a bad connection or a disconnection
 - During electrical storms

⚠ CAUTION

- Use only the power cord included with this machine.
- Do not use extension cords or multi-plug adapters with any other appliances plugged into them. Fire or electric shock may result.
- Do not touch the plug with wet hands. Electric shock may result.
- When unplugging the machine, always turn the main power to OFF first. Always grasp the plug to remove it from the electrical outlet. Pulling on the cord may damage the cord, or lead to fire or electric shock.
- Do not allow the power cord to be cut, damaged, modified, forcefully bent, pulled, twisted, or bundled. Do not place heavy objects on the cord. Do not subject the cord to heat. These things may damage the cord, or cause fire or electric shock. If the cord or plug is damaged, take the machine to your authorized Brother dealer for repairs before continuing use.
- Unplug the power cord if the machine is not to be used for a long period of time. Otherwise, a fire may result.

- (For U.S.A. only)
This appliance has a polarized plug (one blade wider than the other). To reduce the risk of electrical shock, this plug is intended to fit in a polarized electrical outlet only one way. If the plug does not fit fully in the electrical outlet, reverse the plug. If it still does not fit, contact a qualified electrician to install the proper electrical outlet. Do not modify the plug in any way.

- 1 Make sure that the machine is turned off (the main power switch is set to “O”), and then plug the power cord into the power supply jack on the right side of the machine.
- 2 Insert the plug of the power cord into a household electrical outlet.

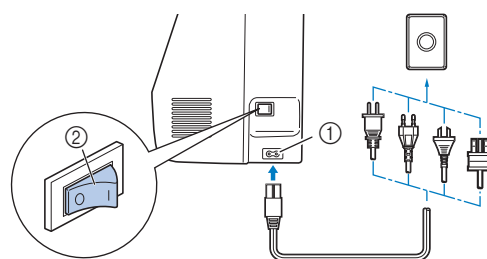

- ① Power supply jack
② Main power switch

- 3 Press the right side of the main power switch on the right side of the machine to turn the machine on (set it to “I”).

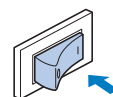

→ The light, LCD and the “Start/Stop” button light up when the machine is turned on. The machine will make a sound when it moves; this is not a malfunction.

📖 Memo

- If the machine is turned off in the middle of embroidering, the operation will resume after turning the power on again.

- 4 When the machine is turned on, the opening movie is played. Press anywhere on the screen.

💡 Note



- When you first turn on the machine, select the language of your choice.



- 5 To turn off the machine, press the left side of the main power switch (set it to “O”).

LCD Operation

Settings screen

Press  to change the default machine settings. Press  or , after you changed necessary settings.

Memo

- The latest version of software is installed in your machine. Check with your local authorized Brother dealer or at “ <http://s.brother/cphan/> ” for available updates.
- You can save the current settings screen image in a USB flash drive by pressing  when the USB flash drive is inserted into the USB port. The files are saved in a folder labeled “bPocket”.

Embroidery settings

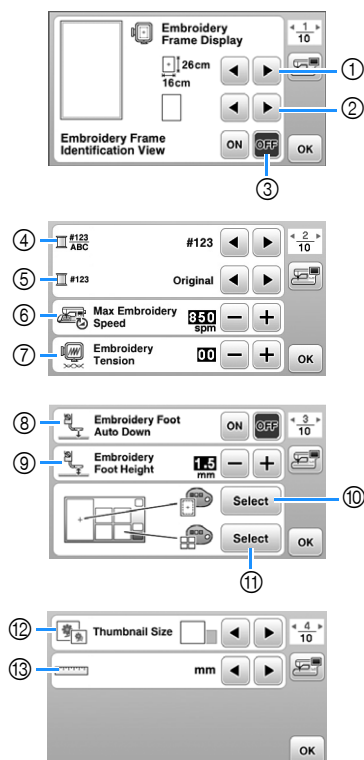

- 1 Select the embroidery frame to be used.
- 2 Select the center mark and grid lines that are displayed.
- 3 When set to [ON], you can only select the embroidery pattern corresponding to the embroidery frame size that you selected in 1. (page 32)
- 4 Change the thread color display on the embroidery screen; thread number, color name. (page 34)
- 5 When the thread number [#123] is selected, select from thread brands. (page 34)
- 6 Select the maximum embroidery speed setting.
- 7 Adjust the upper thread tension for embroidering. (page 37)
- 8 When set to [ON], pressing the "Start/Stop" button when the presser foot is raised automatically lowers the presser foot before starting embroidering. (page 36)
- 9 Select the height of the embroidery foot during embroidering. (page 27)
- 10 Select the color of the background for the embroidery display area.
- 11 Select the color of the background for the thumbnail area.

- 12 Select the size of pattern thumbnails.
- 13 Select the display units (mm/inch).

General settings

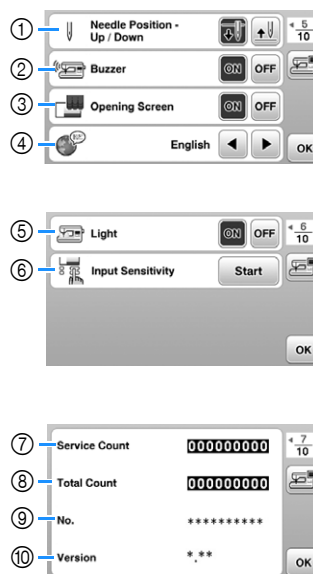

- 1 Select the needle stop position (the needle position for when the machine is not being operated) to be up or down.
- 2 Select whether to hear the beep operation sound.
- 3 Select whether to display the opening screen when the machine is turned on.
- 4 Select the display language.
- 5 Select whether to turn work area light on or off.
- 6 Select the level of the input sensitivity for operation keys. (page 13)
- 7 Display the service count which is a reminder to take your machine in for regular servicing. (Contact your authorized Brother dealer for details.)
- 8 Display the total number of stitches embroidered on this machine.
- 9 The [No.] is the internal machine number for your machine.
- 10 Display the program version installed on your machine.

■ Wireless LAN settings

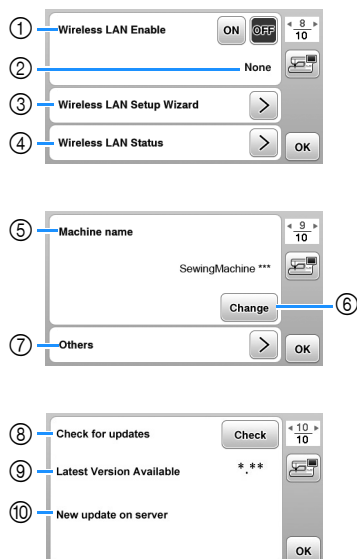

- ① Enable/disable the wireless LAN function. (page 14).
- ② Display the connected SSID. (page 14)
- ③ Set the machine to connect wireless LAN function. (page 14)
- ④ Check the wireless LAN status.
- ⑤ Display the machine name of wireless LAN function.
- ⑥ Change [Machine name].
- ⑦ Display a menu to perform other settings or reset the connection settings of the wireless LAN settings. (page 16)
- ⑧ Check the latest version of the software. The version will display in [Latest Version Available].
- ⑨ Display the latest version of the software.
- ⑩ Displays a message if [New update on server] is available for this machine. If [New update on server] appears, update the machine. (page 57)

Adjusting input sensitivity for operation keys

You can adjust the sensitivity of the operation keys to 5 levels. Display the settings screen to set desired level.

- 1 Press to display the settings screen.
- 2 Display page 6 by pressing .
- 3 Press [Start].

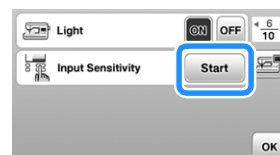

- 4 Adjust the [Input Sensitivity] by pressing .
 - The higher the setting, the more sensitive the keys will be. The default setting is [3].
 - We recommend selecting the highest setting if an electrostatic touch pen is being used.
 - While adjusting the input sensitivity, press to check whether the key responds. When the key responds, the setting value indicating the sensitivity blinks.

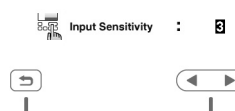

- 5 Press to return to previous screen.

■ If the machine does not respond when an operation key is pressed

Turn machine off, then hold down (Thread cutter button) and turn on the machine to reset [Input Sensitivity]. Display the settings screen, and then adjust the [Input Sensitivity] again.

Wireless Network Connection Functions

Operations available with a wireless network connection

This machine supports a wireless network connection. The following useful operations will be available if the machine is connected to a wireless network.

Note

- Connect the machine and your computer to the same network.
- Wirelessly transfer an embroidery pattern from your computer to the machine by using the dedicated Windows application (Design Database Transfer). The application can be downloaded from the following URL.
<http://s.brother/cahkb/>
- * Settings must be specified in Design Database Transfer. For more information, refer to the manual for Design Database Transfer.

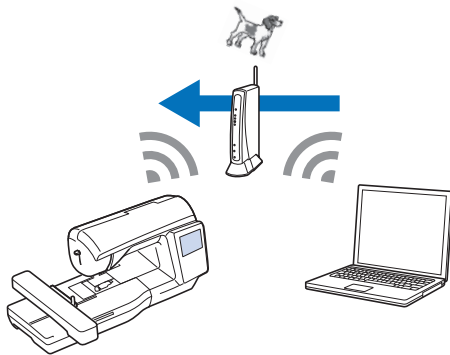

- Wirelessly transfer to the machine an embroidery pattern edited with embroidery editing software (PE-DESIGN version 11 or later) on a computer. Also, transfer to PE-DESIGN an embroidery pattern edited on the machine.
- * Settings must be specified in PE-DESIGN. For more information, refer to the manual for PE-DESIGN.

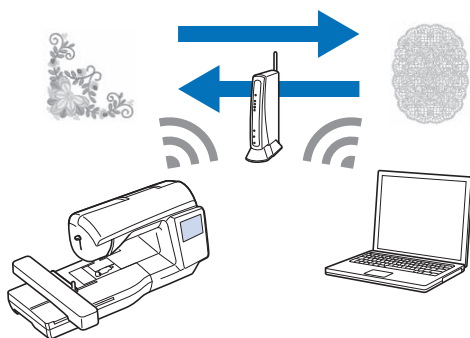

Enabling a wireless network connection

The machine can be connected to your wireless network.

- 1 Press to display the settings screen.
- 2 Display page 8 by pressing .
- 3 Set [Wireless LAN Enable] to [ON].

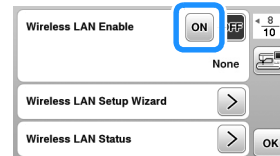

→ The machine prepares for wireless connection.

Requirements for a wireless network connection

The wireless network connection complies with IEEE 802.11 b/g/n standards and uses the 2.4 GHz frequency.

Memo

- A wireless network cannot be set up with WPA/WPA2 Enterprise.

Using the wizard to set up the wireless network connection

There are multiple ways to set up the wireless network connection. We recommend the method that uses the wizard on this machine.

- 1 In order to connect your machine to a wireless network, the security information (SSID and network key) for your home network will be required. The network key may also be called a password, security key or encryption key. Check your security information, and write it in the space below.

SSID	Network key (password)

Memo

- The wireless network connection cannot be set up if you do not have the security information.
- How to find the security information
 - ① Check the manual provided with your home network.
 - ② The default SSID may be the manufacturer's name or the model name.
 - ③ If you cannot find the security information, contact the manufacturer of the router, your network administrator or your Internet provider.
 - ④ Some SSIDs and network keys (passwords) may be case sensitive.

- 2 Press **>** beside [Wireless LAN Setup Wizard].

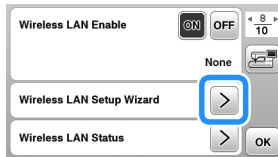

→ A list of available SSIDs appears.

- 3 Select the SSID that was noted.

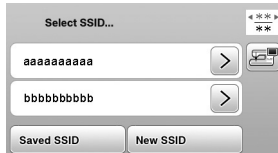

→ The screen for entering the network key (password) appears.

Memo

- When displaying next or previous pages, press **◀** or **▶** key to search the SSID that was noted.
- If the desired SSID is not listed, specify it as described below.
 - ① Press **New SSID** in the end of the SSID list.
 - ② Enter the desired SSID, and then press **OK**.
 - ③ Select the authentication method and encryption mode.
- If using a previous connection, press **Saved SSID**, and then select the saved SSID.

- 4 Enter the network key (password) that was noted, and then press **OK**.

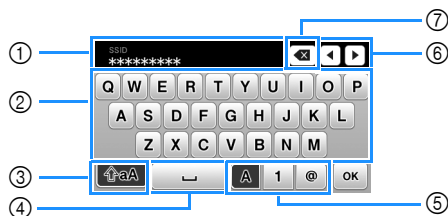

- ① Text input area
- ② Character keys
- ③ Caps key
- ④ Space key
- ⑤ Letters/numbers/symbols key
- ⑥ Cursor keys (Move the cursor to the left or right.)
- ⑦ Backspace key (Deletes the character at the cursor's position.)

- 5 When the following message appears, press **OK**.

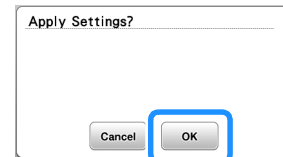

→ When a connection is established, the following message appears.

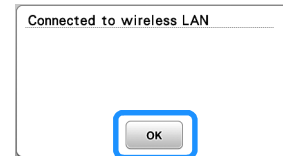

- 6 Press **OK** to exit the setup.



→ Use the [Machine name] on page 9 of the settings screen for the wireless LAN function.

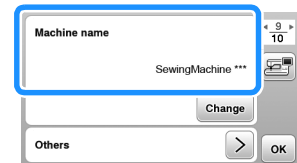

Memo

- While connected, the signal strength can be confirmed by the wireless LAN key in the lower right of the pattern type selection screen.

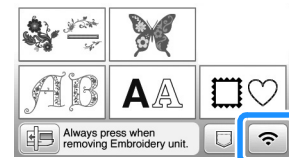

- Once a wireless network connection has been set up, a wireless network connection will be established each time the machine is turned on. However, [Wireless LAN Enable] in the wireless LAN settings screen must remain set to [ON].

■ Setting the wireless LAN connection from the [Others] menu

The [Others] menu on page 9 of the settings screen contains the following items.

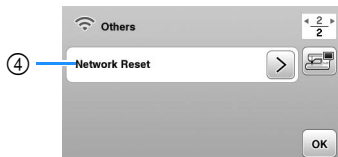
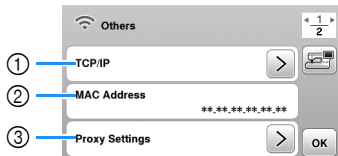
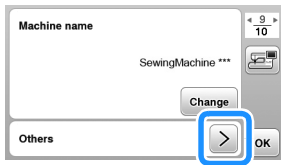

- ① TCP/IP settings can be manually entered.
- ② Shows the MAC address.
- ③ Use when proxy settings are required.
- ④ Resets the wireless LAN connection settings.

Winding/Installing the Bobbin

⚠ CAUTION

- Use the plastic bobbin that comes with this machine or bobbins of the same type. The bobbin's height is 11.5 mm (approx. 7/16 inch). SA156 is Class 15 type bobbin.

Winding the bobbin

This section describes how to wind thread onto a bobbin.

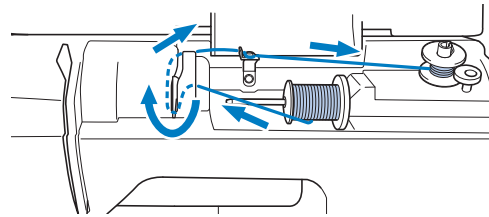

📖 Memo

- When winding bobbin for embroidery, be sure to use the recommended bobbin thread for this machine.

- 1 Open the top cover.

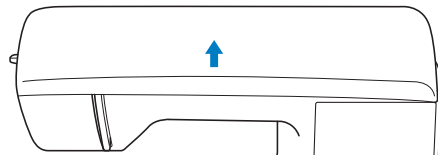

- 2 Place the bobbin on the bobbin winder shaft so that the notch in the bobbin aligns with the spring on the shaft, and then slide the bobbin winder shaft to the right until it snaps into place.

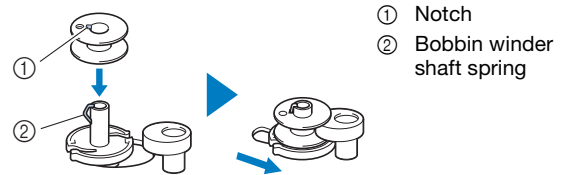

Memo

- By placing the bobbin into the bobbin case in the same orientation that it was on the bobbin winder shaft, the bobbin can be installed with the correct winding direction of the bobbin thread.

The “b” mark on one side of the bobbin included with this machine can be used as a reference.

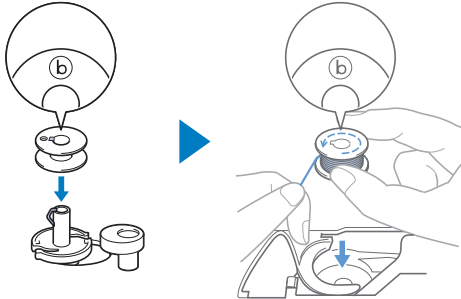

3 Remove the spool cap and place the spool of thread for the bobbin onto the spool pin.

Slide the spool onto the spool pin so that the thread unwinds to the front from the bottom. Otherwise the thread may become tangled around the spool pin.

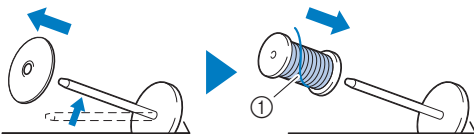

① The thread unwinds to the front from the bottom.

4 Slide the spool cap onto the spool pin.

Slide the spool cap as far as possible to the right, as shown, with the rounded side on the left.

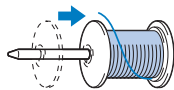

⚠ CAUTION

- If the spool or the spool cap is not installed correctly, the thread may become tangled around the spool pin, causing the needle to break.
- Three spool cap sizes are available, allowing you to choose a spool cap that best fits the size of spool being used. If the spool cap is too small for the spool being used, the thread may catch on the slit in the spool or the machine may be damaged. When using mini king thread spool, use the thread spool insert (mini king thread spool).

For details on thread spool insert (mini king thread spool), refer to “Memo” on page 17.



Memo

- When using the spool as shown below, use the thread spool insert (mini king thread spool). Make sure that the thread spool insert is firmly inserted. After installing it, pull out some thread, and check that the thread unwinds without getting caught.

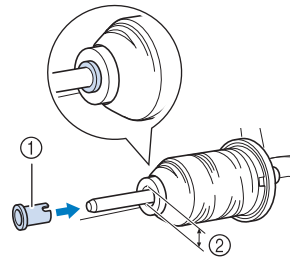

- ① Thread spool insert (mini king thread spool)
- ② Hole diameter 8.0 mm to 10.5 mm (5/16 inch to 13/32 inch)
- ③ Spool (cross-wound thread)

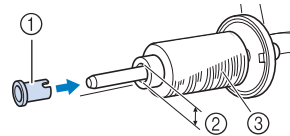

- When using thread that winds off quickly, such as metallic thread, place the spool net over the spool before placing the spool of thread onto the spool pin. If the spool net is too long, fold it to fit the size of the spool.

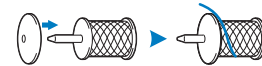

5 While holding the thread near the spool, pass the thread through the thread guide cover. And then, pass the thread under the thread guide plate, and pull it to the right.

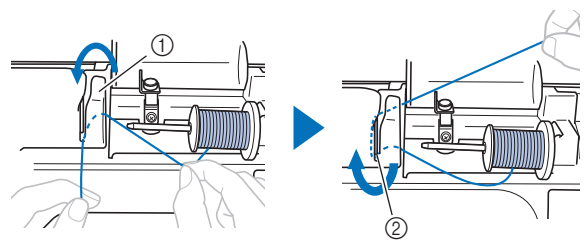

- ① Thread guide cover
- ② Thread guide plate

- 6** Pass the thread under the hook on the bobbin winding thread guide, and then wind it counterclockwise under the pretension disk.

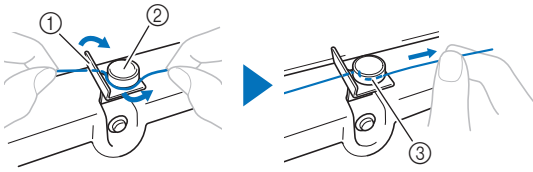

- ① Bobbin winding thread guide
- ② Pretension disk
- ③ Pull it in as far as possible

Note

- Make sure that the thread is passed under the pretension disk.

- 7** Wind the thread clockwise around the bobbin 5 or 6 times, pass the thread through the guide slit in the bobbin winder seat, and then pull the thread to cut it.

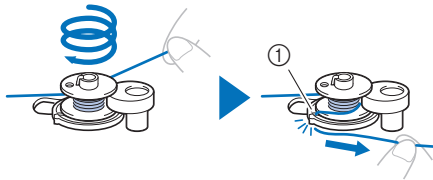

- ① Guide slit in bobbin winder seat (with built-in cutter)

Note

- Be sure to wind the thread clockwise around the bobbin, otherwise the thread will become wrapped around the bobbin winder shaft.

CAUTION

- Be sure to cut the thread as described. If the bobbin is wound without cutting the thread using the cutter built into the guide slit in the bobbin winder seat, the thread may become tangled in the bobbin or the needle may bend or break when the bobbin thread starts to run out.

- 8** Turn on the machine.
- The “Start/Stop” button lights up in orange.
- 9** Press the “Start/Stop” button to start winding the bobbin.

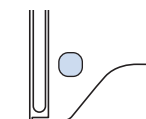

- 10** When the bobbin winding becomes slow, press the “Start/Stop” button to stop the machine.

CAUTION

- When the bobbin winding becomes slow, stop the machine, otherwise the machine may be damaged.

- 11** Cut the thread, slide the bobbin winder shaft to the left until it snaps into place, and then remove the bobbin.

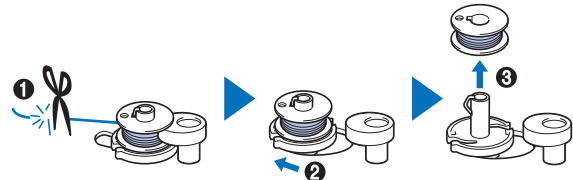

- 12** Remove the spool for the bobbin thread from the spool pin.

Installing the bobbin





Install the bobbin wound with thread.
You can begin embroidering immediately without pulling up the bobbin thread by simply inserting the bobbin in the bobbin case and guiding the thread through the slit in the needle plate cover.

⚠ CAUTION

- Use a bobbin that has been correctly wound with thread, otherwise the needle may break or the thread tension will be incorrect.



- Before inserting or changing the bobbin, be sure that you have pressed  on the operation panel to lock all keys and buttons, otherwise injuries may occur if the "Start/Stop" button or any other button is pressed and the machine starts.

- 1 Turn on the machine.
- 2 Press  (Needle position button) once or twice to raise the needle.
- 3 Press .
 - When the message [OK to automatically lower the presser foot?] appears on the LCD screen, press  to continue.
 - The screen changes, and all keys and operation buttons are locked (except .

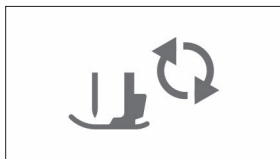

- 4 Raise the presser foot lever.

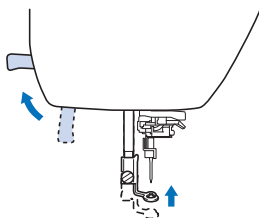

- 5 Slide the bobbin cover latch to the right and remove the bobbin cover.

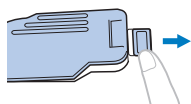

- 6 Insert the bobbin into the bobbin case so that the thread unwinds to the left.

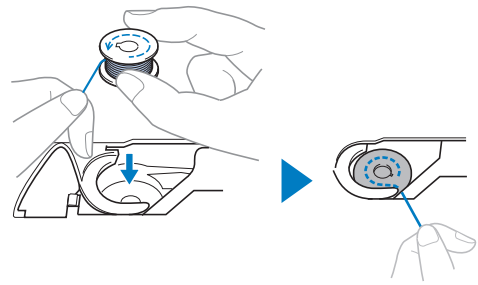

📌 Memo

- For the correct winding direction of the bobbin thread, be sure to place the bobbin into the bobbin case in the same orientation that it was on the bobbin winder shaft.

The "b" mark on one side of the bobbin included with this machine can be used as a reference.

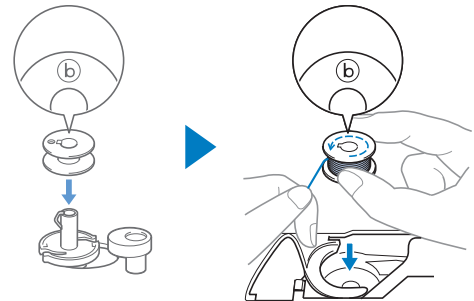

- 7 Lightly hold down the bobbin with your right hand (1), and then guide the end of the thread around the tab of the needle plate cover with your left hand (2).

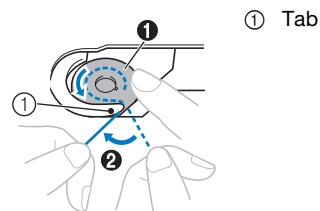

⚠ CAUTION

- Be sure to hold down the bobbin with your finger and unwind the bobbin thread correctly, otherwise the thread may break or the thread tension will be incorrect.

- 8 While lightly holding down the bobbin with your right hand (1), guide the thread through the slit in the needle plate cover (2) and lightly pull it with your left hand (3).

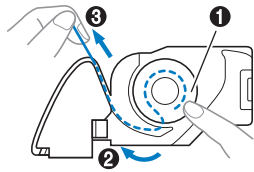

Memo

- By guiding the thread around the tab of the needle plate cover, passing the thread as shown by 2 in this illustration, then lightly pulling the thread at 3, the thread will enter the tension spring of the bobbin case to apply the appropriate tension to the bobbin thread during embroidering.

- 9 While lightly holding down the bobbin with your right hand (1), continue guiding the thread through the slit with your left hand (2). Then, cut the thread with the cutter (3).

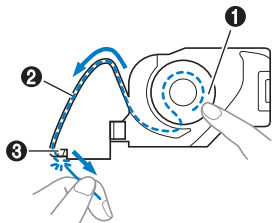

Memo

- Be sure to complete the bobbin threading correctly according to these instructions. If the thread is simply placed in the slit in the needle plate cover, the bobbin thread will not be correctly threaded, resulting in poor embroidering performance or incorrect thread tension.

- 10 Reattach the bobbin cover.

Insert the tab of the bobbin cover into the notch of the needle plate cover, and then lightly press down on the right side.

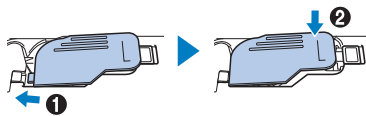

- 11 Press  to unlock all keys and buttons.

Upper Threading

CAUTION

- When threading the upper thread, carefully follow the instructions. If the upper threading is not correct, the thread may become tangled or the needle may bend or break.
- Never use a thread weight of 20 or lower.

Threading the upper thread

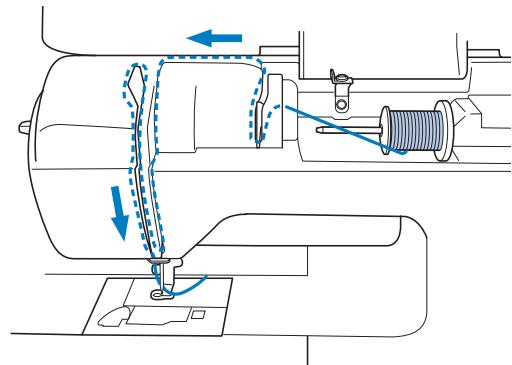

→ When threading the upper thread, carefully follow the instructions.

- 1 Turn on the machine.

- 2 Press  (Needle position button) once or twice to raise the needle.

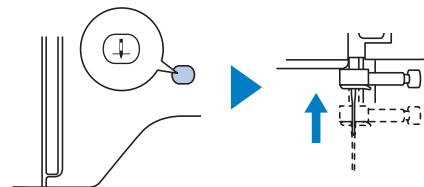

- 3 Press .

- When the message [OK to automatically lower the presser foot?] appears on the LCD screen, press  to continue.

→ The screen changes, and all keys and operation buttons are locked (except .

CAUTION

- When threading the needle, be sure that you have pressed  on the operation panel to lock all keys and buttons, otherwise injuries may occur if the "Start/Stop" button or any other button is pressed and the machine starts.

- 4 Use the presser foot lever to raise the presser foot.

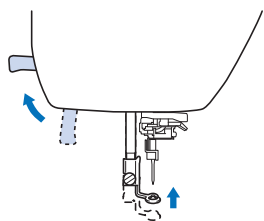

Memo

- If the presser foot is not raised, the machine cannot be threaded.

- 5 Remove the spool cap and place the spool of thread onto the spool pin.

Slide the spool onto the spool pin so that the thread unwinds to the front from the bottom. Otherwise the thread may become tangled around the spool pin.

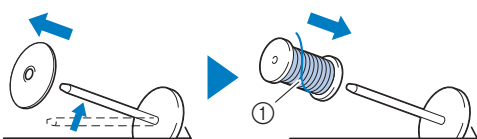

- ① The thread unwinds to the front from the bottom.

- 6 Slide the spool cap onto the spool pin.

Slide the spool cap as far as possible to the right, as shown, with the rounded side on the left.

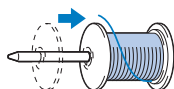

CAUTION

- Choose a spool cap that best fits the size of spool being used. For more information regarding the choice of spool caps for your thread choice, refer to "Memo" on page 17.

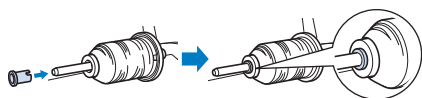

- If the spool or the spool cap is not positioned correctly, the thread may become tangled around the spool pin or the needle may break.

- 7 While holding the thread near the spool, pass the thread through the thread guide cover. And then, pass the thread under the thread guide plate, and pull it up.

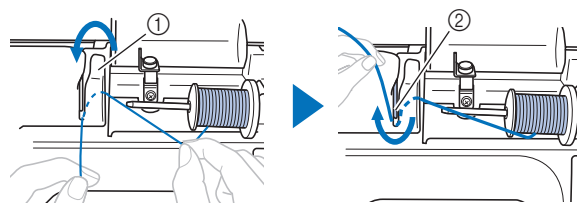

- ① Thread guide cover
② Thread guide plate

- 8 While holding the thread passed under the thread guide plate, pass the thread through the thread channel in the order shown below.

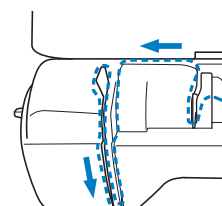

Note

- If the presser foot has been lowered and the shutter is closed, the machine cannot be threaded. Be sure to raise the presser foot to open the shutter before threading the machine. In addition, before removing the upper thread, be sure to raise the presser foot to open the shutter.
- This machine is equipped with a window that allows you to check the position of the take-up lever. Look through this window and check that the thread is correctly fed through the take-up lever.

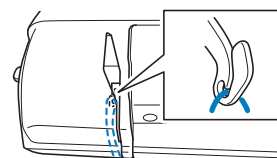

- 9 Slide the thread behind the needle bar thread guide.

The thread can easily be slid behind the needle bar thread guide by holding the thread in your left hand, then feeding the thread with your right hand, as shown. Make sure that the thread is passed through to the left of the tab of the needle bar thread guide.

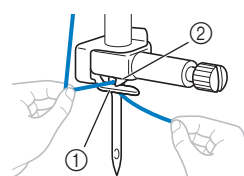

- ① Needle bar thread guide
② Tab

10 Check that the needle and thread are compatible with the needle threader. If they are compatible, continue with the next step.

- The needle threader can be used with machine needles 75/11 through 90/14.
- If the needle threader cannot be used, insert the thread through the eye of the needle from front to back by hand. At this time, be sure to lock all keys and operation buttons described in step **3**.

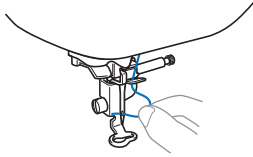

11 Pull the end of the thread, which has been passed through the needle bar thread guide, to the left, then pass the thread through the notch of the threader thread guide, and then firmly pull the thread from the front and insert it into the slit of the threader thread guide disk marked "7" all the way.

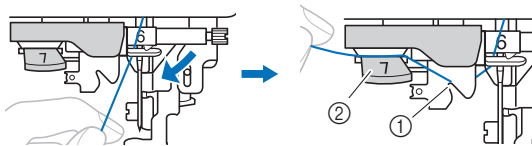

- ① Notch of the threader thread guide
- ② Threader thread guide disk

12 Lower the presser foot lever to lower the presser foot.

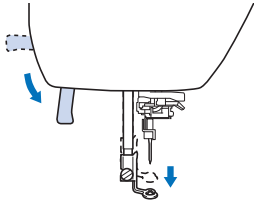

13 Cut the thread with the thread cutter on the left side of the machine.

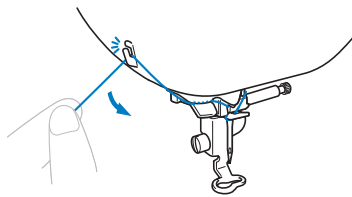

Note

- When using thread that quickly winds off the spool, such as metallic thread, it may be difficult to thread the needle if the thread is cut. Therefore, instead of using the thread cutter, pull out about 8 cm (approx. 3 inches) of thread after passing it through the threader thread guide disk (marked "7").

14 Lower the needle threader lever on the left side of the machine until it clicks, and then slowly return the lever to its original position.

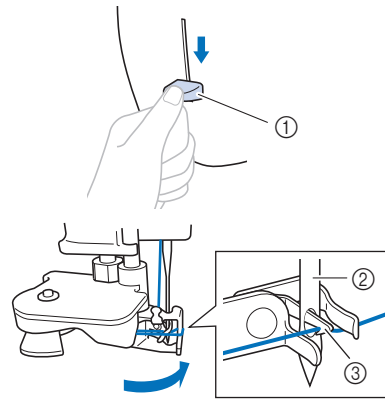

- ① Needle threader lever
- ② Needle
- ③ Hook

Note

- If the needle is not raised to its highest position, the needle threader cannot thread the needle. If the needle is not at the highest position, turn handwheel counterclockwise until the needle is at its highest position.

15 Carefully pull the end of thread that was passed through the eye of the needle.

If the needle was not completely threaded, but a loop in the thread was formed in the eye of the needle, carefully pull the loop through the eye of the needle to pull out the end of the thread.

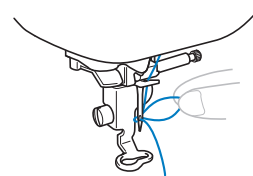

16 Raise the presser foot lever, pass the end of the thread through and under the presser foot, and then pull out about 10 cm (approx. 4 inches) of thread toward the rear of the machine.

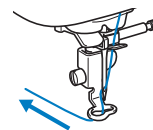

17 Press  to unlock all keys and buttons.

Replacing the Needle

⚠ CAUTION

- Only use recommended home sewing machine needles. Use of any other needle may bend the needle or damage the machine.
- Never use bent needles. Bent needles can easily break, possibly resulting in injuries.

■ Thread and needle number

The lower the thread number is, the heavier the thread; the higher the needle number, the larger the needle.

■ Embroidery needles

It is recommended to use a 75/11 home sewing machine needle. However, if the machine is not stitching well when embroidering on heavy weight fabric, please try a 90/14 needle.

Checking the needle

Before using the needle, place the flat side of the needle on a flat surface and check that the distance between the needle and the flat surface is even.

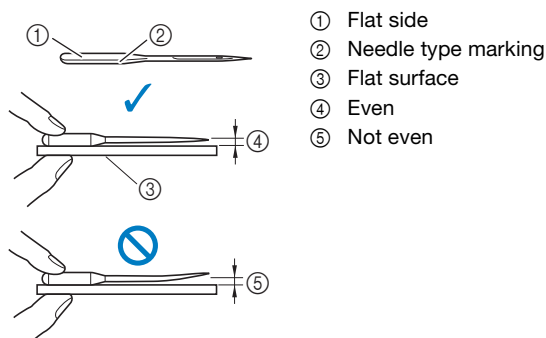

💡 Note

- The machine needles are consumables. Replace the needle in cases such as those described below.
 - If an unusual sound is produced when the needle enters the fabric. (The tip of the needle may be broken or dull.)
 - If stitches are skipped. (The needle may be bent.)

Replacing the needle

Use the screwdriver and a new needle that has been determined to be straight according to the instructions in "Checking the needle" on page 23.

- 1 Press (Needle position button) once or twice to raise the needle.
- 2 Place fabric or paper under the presser foot to cover the hole in the needle plate to prevent the needle from falling into the machine.
- 3 Press .
 - When the message [OK to automatically lower the presser foot?] appears on the LCD screen, press to continue.
 → The screen changes, and all keys and operation buttons are locked (except).



⚠ CAUTION

- When replacing the needle, be sure that you have pressed on the operation panel to lock all keys and buttons, otherwise injuries may occur if the "Start/Stop" button or any other button is pressed and the machine starts.

- 4 Follow steps 3 to 4 "Replacing the embroidery foot" on page 50 for removing the presser foot.
- 5 Hold the needle with your left hand, and then use a screwdriver to turn the needle clamp screw toward you (counterclockwise) to remove the needle.

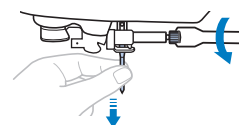

- Do not apply a strong force when loosening or tightening the needle clamp screw, otherwise certain parts of the machine may be damaged.

- 6 With the flat side of the needle toward the rear of the machine, insert the new needle until it touches the needle stopper. Using the screwdriver tighten the needle clamp screw by turning it clockwise.

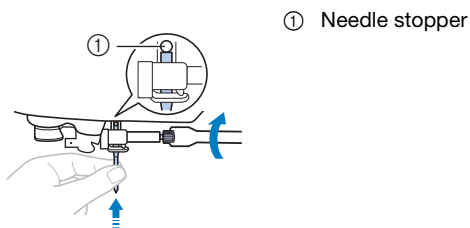

⚠ CAUTION

- Be sure to insert the needle until it touches the needle stopper and securely tighten the needle clamp screw with the screwdriver, otherwise the needle may break or damage may result.

- 7 Follow steps 5 to 7 “Replacing the embroidery foot” on page 50 for reattaching the presser foot.

- 8 Press  to unlock all keys and buttons.

Chapter 2 EMBROIDERY

2

EMBROIDERY

Embroidering Preparation

Follow the steps below to prepare the machine for embroidery.

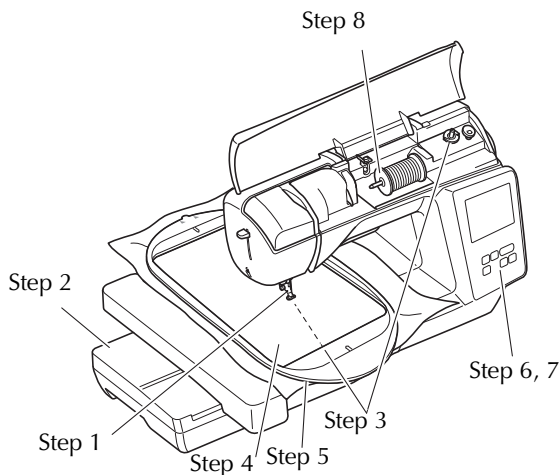

Step #	Aim	Action	Page
1	Checking the needle	Use needle for embroidery.	23
2	Embroidery unit attachment	Attach the embroidery unit.	25
3	Bobbin thread setup	For the bobbin thread, wind embroidery bobbin thread and set it in place.	16
4	Fabric preparation	Attach a stabilizer material to the fabric, and hoop it in the embroidery frame.	27
5	Embroidery frame attachment	Attach the embroidery frame to the embroidery unit.	29
6	Pattern selection	Select an embroidery pattern.	31
7	Checking the layout	Check and adjust the size and position of the embroidery.	33
8	Embroidery thread setup	Set up embroidery thread according to the pattern.	34

Attaching the embroidery unit

⚠ CAUTION

- Before attaching the embroidery unit, be sure to turn off the machine. Otherwise, injuries may occur if one of the operation buttons is accidentally pressed and the machine starts embroidering.
- Do not move the machine with the embroidery unit in place. The embroidery unit may be dropped and cause injury.
- Keep your hands and other objects away from the embroidery carriage and frame when they are moving. Otherwise injury may result.

1 Turn off the machine.

2 Slide the tab on the cover of the connection port in the direction of the arrow to open the cover.

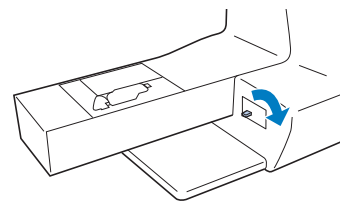

Note

- Be sure to close the cover of the connection port when the embroidery unit is not being used.

3 Insert the embroidery unit connection into the connection port, and then lightly push in the embroidery unit until it snaps into place.

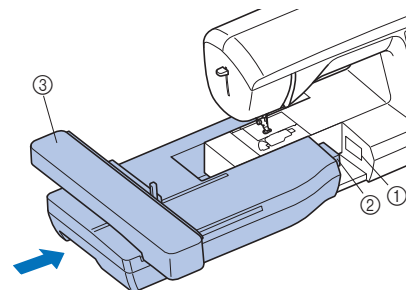

- ① Connection port
- ② Embroidery unit connection
- ③ Carriage

Note

- Make sure that there is no gap between the embroidery unit and the machine, otherwise the embroidery pattern may not be embroidered correctly. Be sure to fully insert the connector into the connection port.
- Do not push on the carriage when attaching the embroidery unit to the machine, otherwise damage to the embroidery unit may result.
- Do not touch the connector in the embroidery unit connection slot. The connector could be damaged, and it may cause malfunctions.
- Do not lift up on the embroidery carriage, and do not forcefully move it. It may cause malfunctions.

4 Turn on the machine.

→ A message appears in the screen.

Note

- If [Opening Screen] is set [ON] within the settings screen, touch screen for the following message to appear.

5 Be sure that no objects or hands are near the embroidery unit and press .

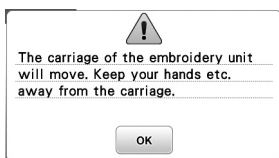

- The carriage moves to its initial position.
- The screen for selecting the embroidery pattern type is displayed.

■ Removing the embroidery unit

Make sure that the machine is completely stopped and follow the instructions below.

1 Remove the embroidery frame.

- For details on removing the embroidery frame, refer to "Removing the embroidery frame" on page 30.

2 Press , and then press .

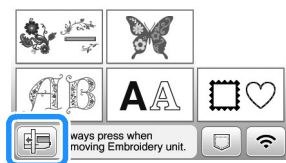

→ The embroidery carriage moves into a position where it can be stored.

3 Turn off the machine.

⚠ CAUTION

- Always turn off the machine before removing the embroidery unit. It may cause malfunctions if removed when the machine is turned on.

4 Hold the release button on the bottom left of the embroidery unit, and slowly pull the embroidery unit to the left.

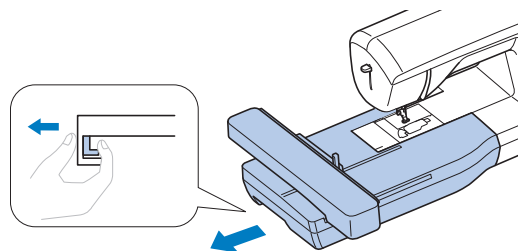

Embroidering attractive finishes

There are many factors that go into beautiful embroidery. Using the appropriate stabilizer (page 28) and hooping the fabric in the frame (page 28) are two important factors mentioned earlier. Another important point is the appropriateness of the needle and thread being used. See the explanation of threads below.

Thread

Upper thread	Use embroidery thread intended for use with this machine. Other embroidery threads may not yield optimum results.
Bobbin thread	Use the included 90 weight embroidery bobbin thread or recommended 90 weight embroidery bobbin thread.

Bobbin case

Bobbin case (recommended for embroidering with included 90 weight bobbin thread)

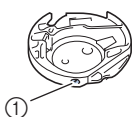

- ① Bobbin case
(no color on the screw)

The bobbin case included with this machine has been set to be used with 90 weight bobbin thread. If different weights of bobbin threads are used the tension screw on this case can be adjusted if necessary. For details on adjusting thread tension, refer to “Adjusting thread tension” on page 37.

- Refer to “Cleaning the race” on page 49 for how to remove the bobbin case.

CAUTION

- When embroidering on large garments (especially jackets or other heavy fabrics), do not let the fabric hang off the table. Otherwise, the embroidery unit cannot move freely and the embroidery frame may strike the needle, causing the needle to bend or break and possibly cause injury. Place the fabric so that it does not hang off the table or hold the fabric to keep it from dragging.

Note

- Do not leave objects in the range of motion of the embroidery frame. The frame may strike the object and cause a poor finish to the embroidery pattern.
- When embroidering on large garments (especially jackets or other heavy fabrics), do not let the fabric hang off the table. Otherwise, the embroidery unit cannot move freely, and the pattern may not turn out as planned.

Hooping the fabric in the embroidery frame

CAUTION

- Use fabrics with a thickness of less than 2 mm (1/16 inch). Using fabrics thicker than 2 mm (1/16 inch) may cause the needle to break.
- Always use a stabilizer material for embroidery when embroidering stretch fabrics, lightweight fabrics, fabrics with a coarse weave, or fabrics which cause pattern shrinkage. Otherwise, the needle may break and cause injury.

Note

- Press . In the [Embroidery Foot Height], use and in the settings screen. Adjust the presser foot height for thick or puffy fabrics.

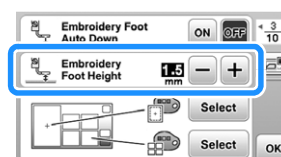

- To increase the space between the presser foot and the needle plate, set the embroidery foot height to a larger number, 1.5 mm setting is used for most embroidery.

■ Attaching iron-on stabilizers (backing) to the fabric

For best results in your embroidery projects, always use stabilizer material for embroidery.

1 Press the iron-on stabilizer material to the wrong side of the fabric.

- Use a piece of stabilizer which is larger than the embroidery frame being used.

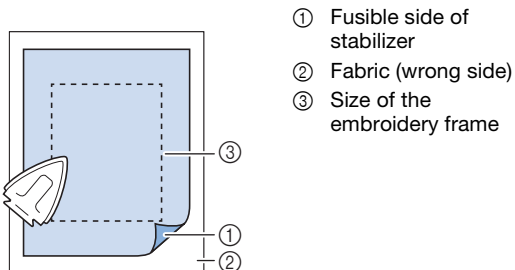

Memo

- When embroidering small pieces of fabric that cannot be hooped on an embroidery frame, use stabilizer material as a base. After lightly ironing the fabric to the stabilizer material, hoop it in the embroidery frame. If stabilizer material cannot be ironed onto the fabric, attach it with a basting stitch. After completing the embroidery, remove the stabilizer material carefully.

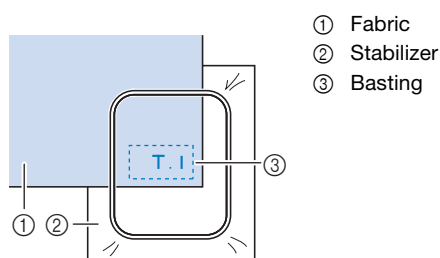

- When embroidering on thin fabrics such as organdy or lawn, or on napped fabrics such as terry cloth or corduroy, use water soluble stabilizer (sold separately) for best results. The water soluble stabilizer material will dissolve completely in water, giving the project a more attractive finish.
- In the case of thick terry cloth towels we recommend that you place a piece of water soluble stabilizer on the top surface of the towel. This will help to reduce the nap of the toweling and result in more attractive embroidery.
- When using fabrics that cannot be ironed (such as terry cloth or fabrics that have loops which expand when ironed) or in places where ironing is difficult, position the stabilizer material under the fabric without fusing it, then position the fabric and stabilizer in the embroidery frame, or check with your authorized Brother dealer for the correct stabilizer to use.

■ Inserting the fabric

⚠ CAUTION

- If you use a frame that is too small, the presser foot may strike the frame during embroidering and cause injury or may damage your machine.

Note

- If the fabric is not securely held in the embroidery frame, the embroidery pattern will stitch out poorly. Insert the fabric on a level surface, and gently pull the fabric taut in the frame, being careful not to distort hooped fabric.

1 Lift-up and loosen the frame adjustment screw and remove the inner frame.

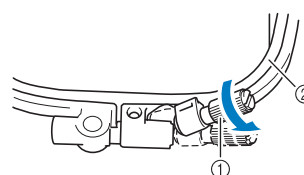

2 Lay the fabric right side up on top of the outer frame.

Re-insert the inner frame making sure to align the inner frame's \triangle with the outer frame's ∇ .

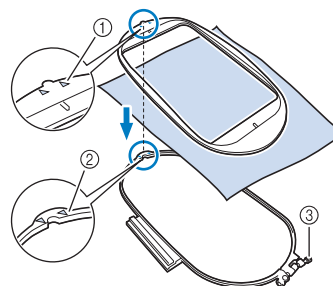

3 Slightly tighten the frame adjustment screw, and then remove the slack in the fabric by gently pulling on the edges and corners. Do not loosen the screw.

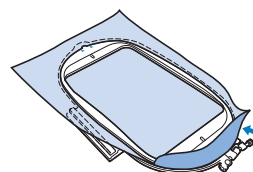

4 Gently stretch the fabric taut, and tighten the frame adjustment screw to keep the fabric from loosening after stretching.

- After stretching the fabric, make sure the fabric is taut.

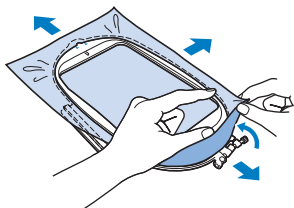

- Make sure the inside and outside frames are even before you start embroidering.

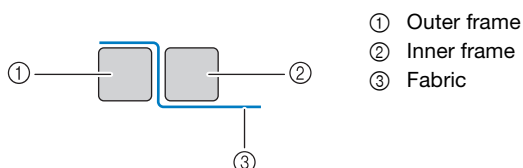

Memo

- After stretching the fabric, lightly tapping it should produce a drum-like sound.
- Stretch the fabric from all four corners and all four edges. While stretching the fabric, tighten the frame adjustment screw.

5 Return the frame adjustment screw to its initial position.

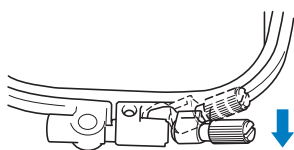

Memo

- You can use the included screwdriver when you loosen or tighten the frame adjustment screw.

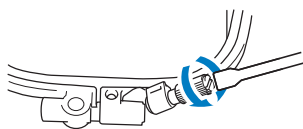

■ Using the embroidery sheet

When you want to embroider the pattern in a particular place, use the embroidery sheet with the frame.

1 With a chalk pencil, mark the area of the fabric you want to embroider.

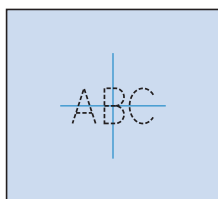

2 Place the embroidery sheet on the inner frame.

3 Line the mark on the fabric up with the base line on the embroidery sheet.

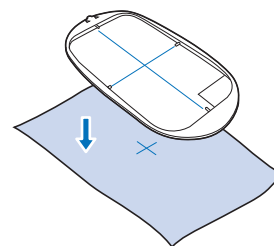

4 Place the inner frame with the fabric on the outer frame and adjust the fabric if needed to align marks on fabric with the embroidery sheet.

5 Remove the embroidery sheet.

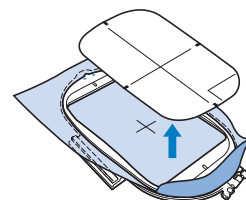

Attaching the embroidery frame

Note

- Wind and insert the bobbin before attaching the embroidery frame making sure to use the recommended bobbin thread. Check that there is enough thread in the bobbin.

1 Press (Presser foot lifter button) to raise the presser foot.

2 Raise the frame-securing lever.

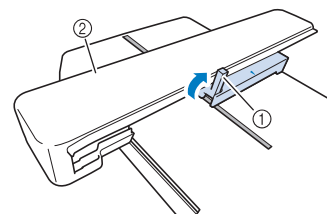

- ① Frame-securing lever
- ② Carriage

- 3 Align the embroidery frame guide with the right edge of the embroidery frame holder.

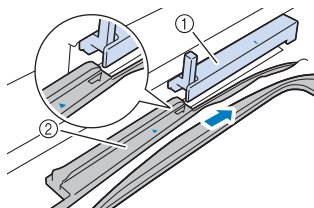

- ① Embroidery frame holder
- ② Embroidery frame guide

- 4 Slide the embroidery frame into the holder, making sure to align the embroidery frame's arrow mark with the one on holder.

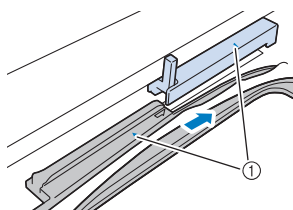

- ① Arrow mark

- 5 Lower the frame-securing lever to be level with the frame to secure the embroidery frame in the embroidery frame holder.

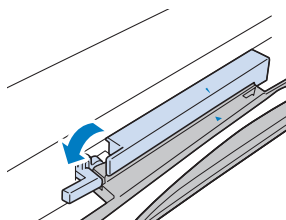

■ Removing the embroidery frame

- 1 Press  (Presser foot lifter button) to raise the presser foot.

- 2 Raise the frame-securing lever.

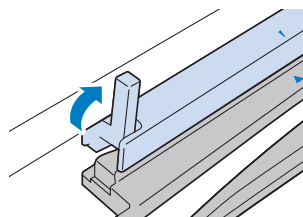

- 3 Pull the embroidery frame toward you.

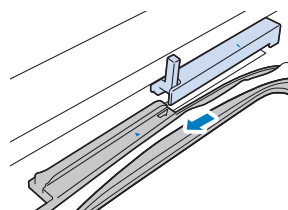

⚠ CAUTION

- If the frame-securing lever is not lowered, the following message appears. You cannot start embroidering until you lower the frame-securing lever.

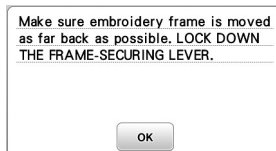

Embroidering

■ Copyright information

The patterns stored in the machine are intended for private use only. Any public or commercial use of copyrighted patterns is an infringement of copyright law and is strictly prohibited.

■ Embroidery pattern types

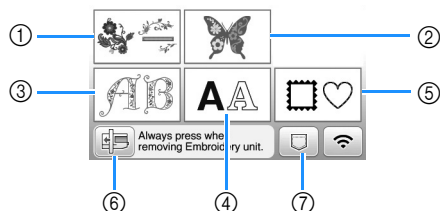

- ① Embroidery patterns
- ② Brother “Exclusives”
- ③ Floral alphabet patterns
- ④ Character patterns
- ⑤ Frame patterns
- ⑥ Press this key to position the embroidery unit for storage
- ⑦ Patterns saved in the machine's memory, patterns saved in USB flash drive, or patterns transferred via wireless network. (page 47)

- Refer to the “Embroidery Design Guide” for more information on each category’s embroidery pattern.

Selecting an embroidery pattern

- 1 Press in the pattern type selection screen, and then press .

- If the pattern type selection screen is not displayed, press to display the screen below.

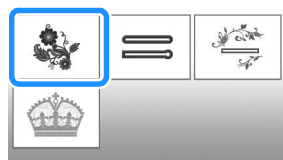
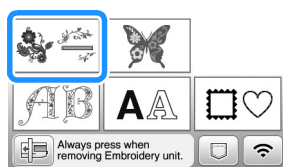

- 2 Press or to display the desired pattern on the screen.

- 3 Select a desired embroidery pattern, and then press .

- Available frame options are displayed on the screen.

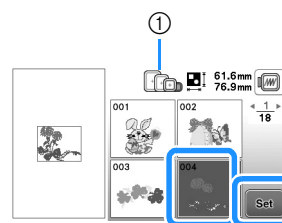

- ① White: Frame which can be used with the selected pattern
Gray: Frame which cannot be used with the selected pattern

→ Pattern editing screen appears.

- 4 Press .

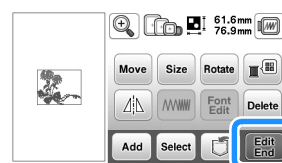

- For details on pattern editing screen, refer to “Editing Patterns (Pattern Editing Screen)” on page 42. You can move the pattern, change the size of pattern, and perform many other editing operations.

- The pattern can also be moved by dragging it with your finger.

→ Embroidery settings screen appears.

- 5 Press .

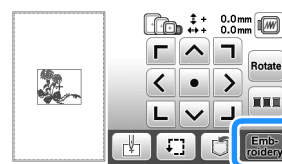

- For details on embroidery settings screen, refer to “Editing Patterns (Embroidery Settings Screen)” on page 44.

- Confirm the pattern position to be embroidered, referring to “Checking the pattern position” on page 33.

Memo

- If [Embroidery Frame Identification View] in the settings screen is set to [ON], the pattern can be edited in the screen as if that embroidery frame is attached.

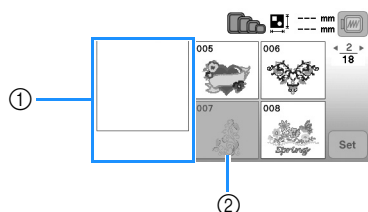
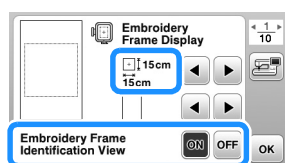

- The embroidering area for the selected frame is displayed.
- Patterns that will not fit in the selected frame appear shaded and cannot be selected.

- There are three embroidering area sizes for embroidery frame (small). When [Embroidery Frame Identification View] is set to [ON] for embroidery frame (small), the area for arranging patterns can more easily be seen. The area outside of the embroidering area will have a different background color.

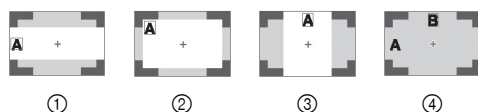

- 2 cm × 6 cm (approx. 1 inch (H) × 2-1/2 inches (W))
- 3 cm × 5 cm (approx. 1-1/8 inches (H) × 2 inches (W))
- 4 cm × 3 cm (approx. 1-1/2 inches (H) × 1-1/8 inches (W))
- Patterns are arranged outside of the embroidering area.

Selecting character patterns

- Press **AA**.
- Press the key of the font you want to embroider.
- Press a tab to display the desired selection screen, and then type in the text.



- Current line number
- Tab

- To enter a space, press **[]**.
- After selecting a character if you would like to change the character size press **[M S]**. The size changes each time you press the key, from large to medium to small. After the character size is changed, all characters on the same line will have the new character size.
- If you make a mistake, press **Delete** to erase the mistake.
- To check all entered characters, for example, when there are multiple text lines, press **Check**.
- To add multiple lines, press **[↵]**.
- When the Japanese font is selected, the text can be switched between being written vertically and horizontally by pressing **[H V]**.

- Press **Set**.

- For details on editing the pattern, refer to "Editing Patterns (Pattern Editing Screen)" on page 42.

Selecting frame patterns

- Press **[□♥]**.
- Press the key of the frame shape you want to embroider.

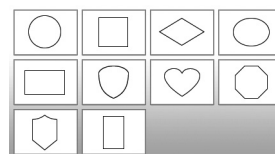

- Press the key of the frame pattern you want to embroider.

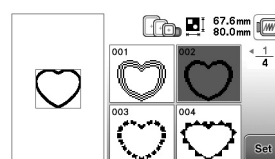

4 Press **Set**.

- For details on editing the pattern, refer to "Editing Patterns (Pattern Editing Screen)" on page 42.

■ Combining patterns

1 Select the pattern and then press **Set**.

2 Edit the pattern if needed, and then press **Add**.

- For details on pattern editing, refer to "Pattern editing screen" on page 42.

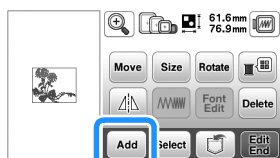

3 Press **A A** to enter the alphabet characters.

4 Select **ABC** and enter "Happy".

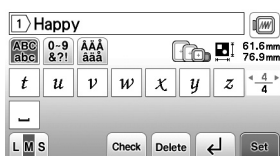

5 Press **Set**.

6 Press **Font Edit** and then select **Array**.

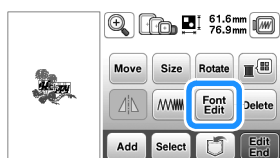

- For details on character editing, refer to "Font editing screen" on page 43.

7 Change the layout of the characters and then press **OK** two times to return to the pattern editing screen.

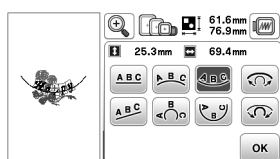

8 Press **Color** to change the color.

9 Change the color of the characters and then press **OK**.

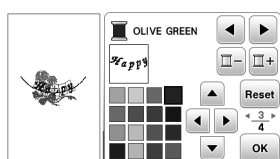

- For details on changing colors, refer to "Pattern editing screen" on page 42.

10 Edit the pattern position.

- The pattern can be selected with your finger and then moved by dragging it. Use **Select** to select patterns that are overlapping and cannot be selected by touching the screen.
- Press **Move** to decide the pattern position carefully.
- Press **Preview** to check the preview of the combined patterns.

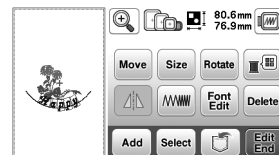

11 Press **Edit End**.

■ Checking the pattern position

The embroidery frame moves and shows the pattern position. Watch the frame closely to make sure the pattern will be embroidered in the right place.

1 Press **Embroidery** on the embroidery settings screen.

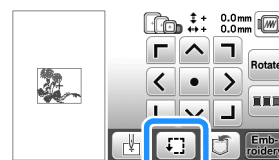

2 From **Embroidery**, press the key for the position that you want to check.

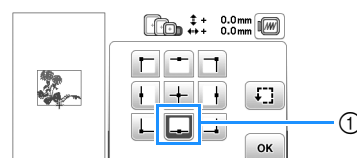

- Selected position
→ The carriage will move to the selected position on the pattern.

Memo

- To see the entire embroidering area, press **Embroidery**. The embroidery frame moves and shows the embroidering area.

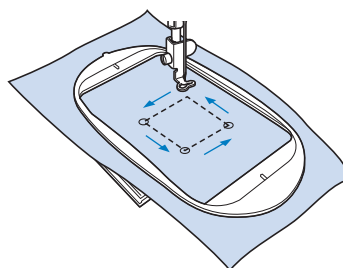

⚠ CAUTION

- Make sure the needle is up when the embroidery frame is moving. If the needle is down, it could break and result in injury.

3 Press **OK**, and then press **Embroidery**.

Embroidering a pattern

Embroidery patterns are embroidered with a change of thread after each color.

1 Prepare embroidery thread colors as shown on the screen.

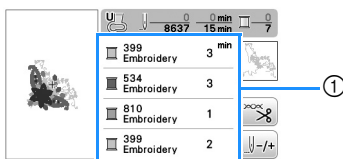

① Embroidery color order

- Either the thread color name or the thread number appears in this screen, depending on the setting selected in the settings screen. Press to change the setting in the settings screen. For details, refer to “Changing the thread color display” on page 35.

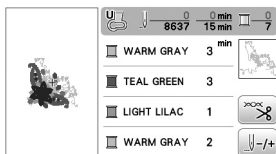

- The automatic thread cutting function will cut the thread at the end of embroidering each color. This function is initially turned on. To turn this function off, press key, and then press .

2 Set the embroidery thread, and thread the needle.

- Refer to “Threading the upper thread” on page 20.

3 Raise the presser foot lever and pass the thread through the embroidery foot hole, and hold it lightly in your left hand.

Give the thread a little slack.

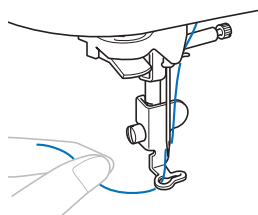

⚠ CAUTION

- Do not let hands or objects hit the carriage while embroidering. The pattern may misalign.
- When embroidering on large garments (especially jackets or other heavy fabrics), do not let the fabric hang off the table. Otherwise, the embroidery unit cannot move freely and the embroidery frame may strike the needle, causing the needle to bend or break and possibly cause injury. Place the fabric so that it does not hang off the table or hold the fabric to keep it from dragging.

4 Lower the presser foot, then press the “Start/Stop” button to start embroidering. After 5-6 stitches, press the “Start/Stop” button again to stop the machine.

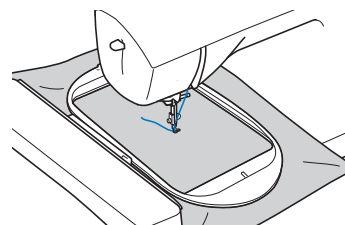

5 Trim the excess thread at the end of the seam. If the end of the seam is under the presser foot, raise the presser foot, then trim the excess thread.

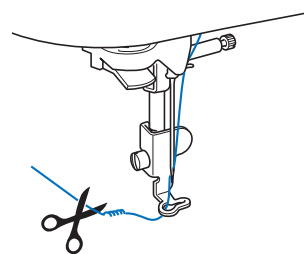

- If the thread is left at the beginning of the stitching, it may be embroidered over as you continue embroidering the pattern, making it very difficult to remove the excess thread after the pattern is finished. Trim the thread at the beginning.

6 Press the “Start/Stop” button to start embroidering.

→ Stitching stops automatically with reinforcement after one color has been completed. When automatic thread cutting is set, the thread is cut.

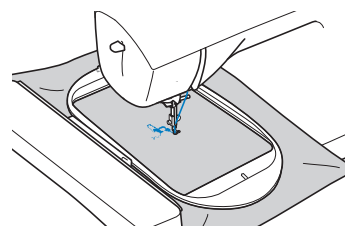

7 Remove the thread for the first color from the machine.

8 Repeat the same steps for embroidering the remaining colors.

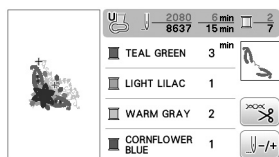

→ When the last color is embroidered, a message informing you the embroidering is finished will appear on the display. Press **OK**, and the display will return to the initial screen.

9 Cut the excess thread jumps within the color.

Changing the thread color display

You can display the name of the thread colors or embroidery thread number.

Memo

- Colors on the screen may vary slightly from actual spool colors.
- [Original], imported data remains the brand thread created with the software, is set as a default.

1 Press **Settings** and use **Left** or **Right** to display the following settings screen.



2 Use **Left** or **Right** of the **#123 ABC** menu to select [Name of Color] or [#123] (thread number).



- When [Name of Color] is selected, the name of the thread colors is displayed.

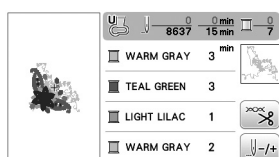

- When [#123] is selected, the embroidery thread number is displayed. Use **Left** or **Right** of the **#123** menu to select the thread brand.

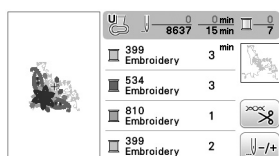

3 Press **OK**.

If the bobbin runs out of thread

When the bobbin begins to run out of thread during embroidering, the machine will stop and the message below will appear. Press **OK** and follow the directions below to replace the bobbin. If very little embroidering remains, you can embroider approximately 10 final stitches without rethreading the machine by pressing **OK**. The machine will stop after embroidering approximately 10 stitches.

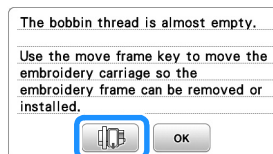

1 Press **OK**.



→ After the thread is automatically cut, the carriage will move.

2 Unlock the frame-securing lever and remove the embroidery frame.

- Be careful not to apply strong force to the fabric at this time. Otherwise, the fabric may loosen in the frame.

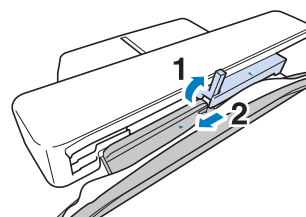

3 Insert a wound bobbin into the machine. (Refer to "Installing the bobbin" on page 19.)

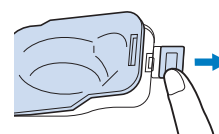

4 Attach the embroidery frame.

5 Press **OK**.

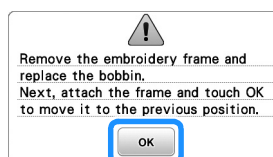

6 Press **OK**.

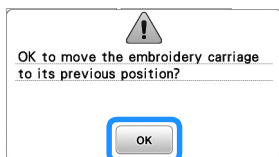

7 To return to the area in the pattern where you stopped embroidering, follow steps 3 through 6 in the next section.

■ If the thread breaks during embroidering

1 Press the “Start/Stop” button to stop the machine.

2 If the upper thread is broken, redo the upper threading. If the bobbin thread is broken, press and follow the directions in steps 1 through 6 from the previous section to reset the bobbin.

3 Press .

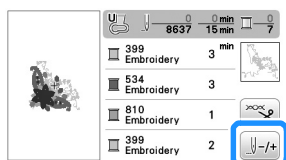

4 Press , , or to move the needle back the correct number of stitches before the area where the thread broke.

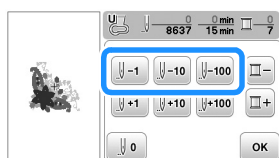

Memo

- If you cannot move back to the area where the thread broke, press to select the color and move to the beginning position of that color, then use , , or to move ahead to slightly before where the thread broke.

5 Press **OK** to return to the original screen.

6 Press (Presser foot lifter button) to lower the presser foot, and press the “Start/Stop” button to continue embroidering.

■ Resuming embroidery after turning off the power

The current color and stitch number are saved when embroidery is stopped. The next time the machine is turned on, you have the option to continue or delete the pattern.

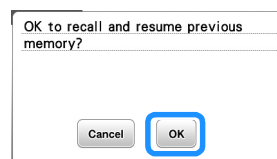

Embroidery Foot Auto Down

You can choose a setting to automatically lower the embroidery foot at the beginning of embroidering.

1 Press to display the settings screen, and then display page 3 by pressing .

2 Set [Embroidery Foot Auto Down] to [ON].

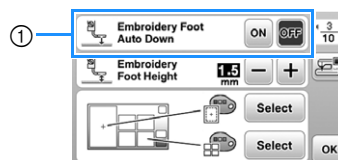



- ① When set to [ON], pressing the “Start/Stop” button when the presser foot is raised automatically lowers the presser foot before starting embroidering.

Adjusting thread tension

The upper thread tension is changed.

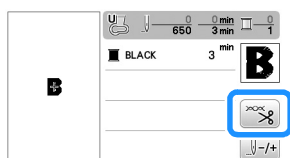
- 1 Press .



- 2 Press  to loosen the upper thread tension. (The tension number will decrease.)
Press  to tighten the upper thread tension. (The tension number will increase.)

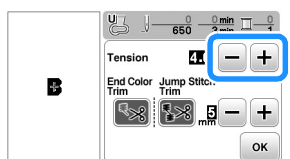

- 3 Press .

Correct thread tension

The thread tension is correct when upper thread is just visible on the wrong side (bottom) of the fabric.



- ① Right side (top) of fabric
- ② Wrong side (bottom) of fabric

Upper thread is too tight

The bobbin thread will be visible on the right side (top) of the fabric. In this instance, decrease the upper thread tension.



- ① Right side (top) of fabric
- ② Wrong side (bottom) of fabric

Upper thread is too loose

The upper thread has slack. In this instance, increase the upper thread tension.





- ① Right side (top) of fabric
- ② Wrong side (bottom) of fabric

Note

- If the upper thread is not threaded correctly or the bobbin is not installed correctly, it may not be possible to set the correct thread tension. If the correct thread tension cannot be achieved, rethread the upper thread and insert the bobbin correctly.

- With [Embroidery Tension] on the setting screen, the tension of the upper thread can be adjusted for embroidering. The selected setting will be applied to all patterns.

When embroidering, if the overall tension of the upper thread is too tight or too loose, adjust it from the setting screen. Press  to tighten the upper thread tension and press  to loosen the upper tension. If an individual embroidery pattern needs additional fine tuning, refer to "Adjusting thread tension" on page 37.

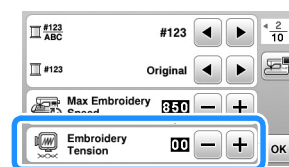

Adjusting the bobbin case (with no color on the screw)

The bobbin case (with no color on the screw) can be adjusted when bobbin tension changes are required to accommodate different bobbin threads. Refer to "Embroidering attractive finishes" on page 27.

To adjust the bobbin tension for embroidery function, using the bobbin case (with no color on the screw), turn the slotted-head screw (-) with a screwdriver (small).

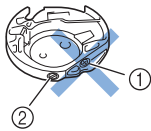

- ① Do not turn the phillips screw (+).
- ② Adjust with a screwdriver (small).

Correct tension

Upper thread slightly appears on the wrong side of fabric.



- ① Right side
- ② Wrong side

Bobbin thread is too loose

Bobbin thread appears slightly on the right side of fabric.

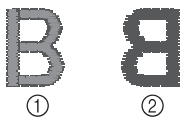

- ① Right side
- ② Wrong side

If this occurs, turn the slotted-head screw (-) clockwise, being careful not to over-tighten the screw, approximately 30-45 degrees to increase bobbin tension.

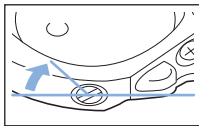

Bobbin thread is too tight

Upper thread on the right side of fabric seems to be lifting/looping and bobbin thread is not seen on the wrong side of fabric.

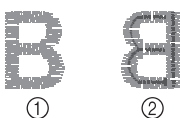

- ① Right side
- ② Wrong side

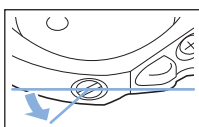

If this occurs, turn the slotted-head screw (-) counterclockwise, being careful not to over-loosen the screw, approximately 30-45 degrees to decrease bobbin tension.



CAUTION

- When adjusting the bobbin case, be sure to remove the bobbin from the bobbin case.
- DO NOT adjust the position of the phillips (+) screw on the bobbin case as this may result in damage to the bobbin case, rendering it unusable.
- If the slotted-head screw (-) is difficult to turn, do not use force. Turning the screw too much or providing force in either (rotational) direction may cause damage to the bobbin case. Should damage occur, the bobbin case may not maintain proper tension.

Using the automatic thread cutting function (End Color Trim)

The automatic thread cutting function will cut the thread at the end of embroidering each color. This function is initially turned on. To turn this function off, press  key and then .

- 1 Press .

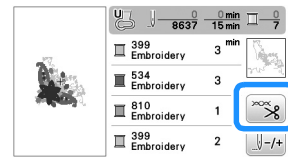

- 2 Press  to turn off the automatic thread cutting function.

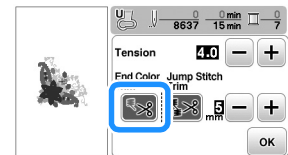



→ The key will display as .

- When one color thread is embroidered, the machine will stop without cutting the thread.

- 3 Press  to return to the original screen.

Using the Thread Trimming Function (Jump Stitch Trim)

The thread trimming function  will automatically trim any excess thread jumps within the color. Embroidery frame (small) cannot be used. This function is initially turned on. To turn this function off, press  key and then .

* Your customized setting remains after turning the machine off and on.

CAUTION

- The carriage of the embroidery unit will move. Keep your hands etc. away from the carriage. Otherwise injury may result.

ABCDEF

① Jump stitch

①



Note

- When this function is turned on, use a ball point needle 75/11 for embroidering patterns (sold separately) with short jump stitches such as alphabet characters. Using other needles may cause the thread to break.

Selecting the Length of Jump Stitch Not to Trim

When the thread trimming function  is turned on, you can select the length at which jump stitch trimming starts.

* Your customized setting remains after turning the machine off and on.

Press  or  to select the length of jump stitch.

For example: Press  to select 25 mm (1 inch) and the machine will not trim a jump stitch of 25 mm or less before moving to the next stitching.

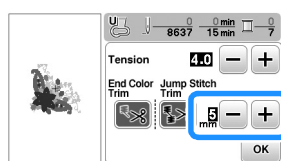

Memo

- If a design has many trims it is recommended to select a higher jump stitch trim setting in order to reduce the amount of excess tails on backside of fabric.
- The higher number of the jump stitch length selected, the fewer number of times the machine will trim. In this case, more jump stitches will remain on the surface of the fabric.

Embroidering the appliqué patterns

When the color embroidering order display shows

 (APPLIQUE MATERIAL),

 (APPLIQUE POSITION)] or

 (APPLIQUE)], follow the procedure below.

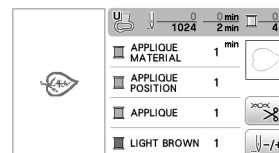

Required materials

- Fabric for the appliqué piece
- Fabric for the appliqué base
- Stabilizer material
- Fabric glue or temporary spray adhesive
- Embroidering thread

Note

- The correct names and numbers of the thread colors to be used will not appear. Select the thread colors depending on those in the appliqué pattern.

1. Creating an appliqué piece

- 1 Attach stabilizer material to the wrong side of the appliqué fabric.
- 2 Sew the cutting line of the appliqué piece. Remove the fabric for the appliqué piece from the embroidery frame, and then carefully cut along the sewn cutting line.

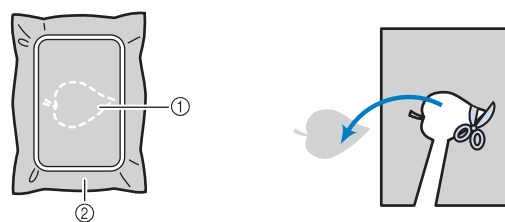

- ① Outline of appliqué
- ② Appliqué material

Note

- If the appliqué piece is cut out along the inside of the cutting line, it may not be correctly attached to the fabric. Therefore, carefully cut out the appliqué piece along the cutting line.
- After cutting out the appliqué piece, carefully remove any remaining thread.

2. Sewing the appliqué position on the base fabric

1 Sew the appliqué position.

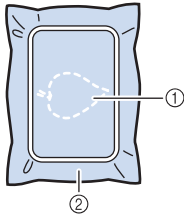

- ① Position of appliqué
- ② Base material

2 Remove the embroidery frame from the embroidery unit.

Note

- Do not remove the base fabric from the embroidery frame until all sewing is finished.

3. Affixing the appliqué piece to the base fabric

1 Lightly apply fabric glue or temporary spray adhesive to the back of the appliqué piece, and then attach it to the base fabric within the outline of the position sewn in step 1 of "2. Sewing the appliqué position on the base fabric".

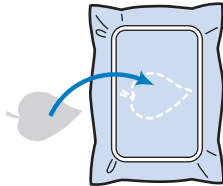

Note

- If the appliqué piece cannot be attached to the base fabric with fabric glue or temporary spray adhesive, securely baste it in place with basting stitches.
- If thin fabric is used for the appliqué piece, reinforce and secure it in place with an iron-on adhesive sheet. An iron can be used to attach the appliqué piece to the appliqué location.

2 After the appliqué piece is attached, attach the embroidery frame to the machine. Thread the machine with the embroidery thread, lower the presser foot lever, and then press the "Start/Stop" button to embroider the appliqué.

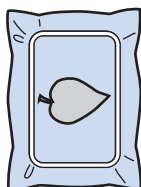

3 Finish embroidering the remainder of the pattern.

Using a frame pattern to make an appliqué

You can use frame patterns of the same size and shape to create an appliqué. Embroider one pattern with a straight stitch and one pattern with a satin stitch.

Method 1

1 Select a straight stitch frame pattern. Embroider the pattern onto the appliqué material, then cut neatly around the outside of the shape.

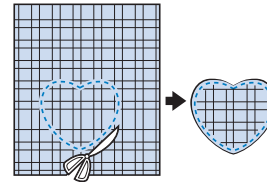
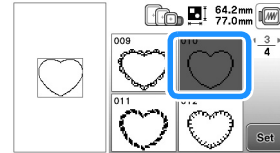

2 Embroider the same pattern from step 1 onto the base fabric. Apply a thin layer of fabric glue or a temporary spray adhesive to the back of the appliqué created in step 1. Attach the appliqué to the base fabric matching the shapes.

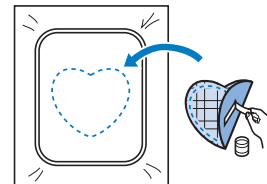

3 Select the satin stitch frame pattern of the same shape as the appliqué. Embroider over the appliqué and base fabric from step 2 to create the appliqué.

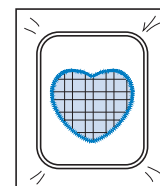
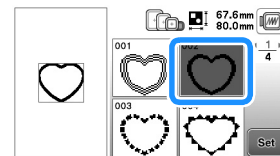

Method 2

- 1 Select a straight stitch frame pattern, and embroider the pattern onto the base fabric.

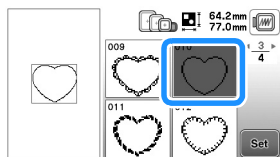

- 2 Place the appliqué fabric over the pattern embroidered in step 1 and embroider the same pattern on the appliqué fabric.
 - Be sure that the appliqué fabric completely covers the stitched line.

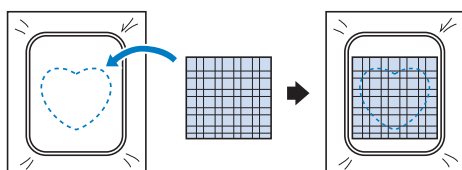

- 3 Remove the embroidery frame from the embroidery unit, and cut around the outside of the stitches of the appliqué fabric.
 - Do not remove the fabric from the embroidery frame to cut it. Also, do not pull or push on the fabric. Otherwise, the fabric may loosen in the frame.

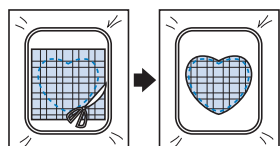

Note

- Do not remove the fabric from the embroidery frame to cut it. Also, do not pull or push on the fabric. Otherwise, the fabric may loosen in the frame.

- 4 Reattach the embroidery frame to the embroidery unit.

- 5 Select the satin stitch frame pattern of the same shape as the appliqué and embroider the satin stitch pattern to create an appliqué.
 - Do not change the size or position of the pattern.

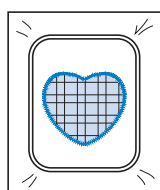
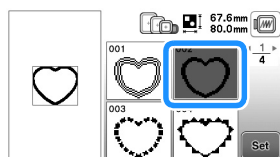

Split embroidery patterns

Split embroidery patterns created with PE-DESIGN Ver.7 or later, or PE-DESIGN NEXT can be embroidered. With split embroidery patterns, embroidery designs larger than the embroidery hoop are divided into multiple sections, which combine to create a single pattern after each section is embroidered.

For details on creating split embroidery patterns and for more detailed embroidery instructions, refer to the Instruction manual included with PE-DESIGN Ver.7 or later, or PE-DESIGN NEXT.

- 1 Insert the USB flash drive containing the created split embroidery pattern, and then select the split embroidery pattern to be embroidered.
 - For details, refer to "Retrieving embroidery patterns" on page 47.

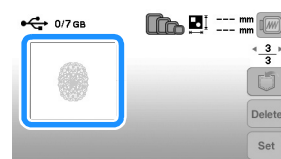

- 2 Select section **Aa** to be embroidered and press **Set**.
 - Select the sections in alphabetical order.

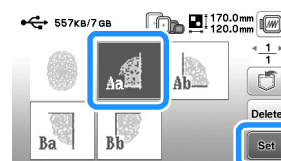

- 3 Press **Edit End** and press **Embroidery**.
 - Select the sections in alphabetical order.

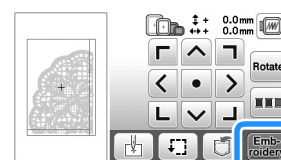

- 4 Press the "Start/Stop" button to embroider the pattern section.

- 5 When embroidering is finished, the following screen appears. Press **OK**.
 - Do not change the size or position of the pattern.

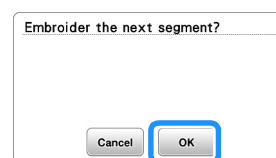

→ A screen appears so that a section of the split embroidery pattern can be selected.

- 6 Repeat steps 2 through 5 to embroider the remaining sections of the pattern.

Editing Patterns (Pattern Editing Screen)

When a pattern is selected in the pattern selection screen and **Set** is pressed, the pattern editing screen appears. After pressing any of the keys to edit the pattern, press **OK** to return to the previous screen. To finish all the editing, press **Edit End** to continue to the embroidery settings screen.

CAUTION

- When you have revised the pattern, check the display of available embroidery frames and use an appropriate frame. If you use an embroidery frame not displayed as available for use, the presser foot may strike the frame and possibly cause injury or damage.

Pattern editing screen

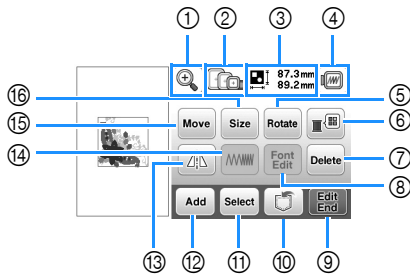

Memo

- If a key display is light gray, you cannot use that function with the selected pattern.

No.	Display	Explanation
	Key Name	
①		Press this key to magnify the pattern in the screen.
	Magnify key	
②		Shows the embroidery frames that can be used (page 31).
	Embroidery frame	
③	61.6mm 76.9mm	Shows the size of the entire combined pattern.
	Pattern size	
④		Press this key to show embroidered image. Press to select the frame used in the preview. <ul style="list-style-type: none"> : Extra large embroidery frame/26 cm × 16 cm (10-1/4 inches × 6-1/4 inches) : Large embroidery frame (sold separately with some models)/18 cm × 13 cm (7 inches × 5 inches) : Medium embroidery frame (sold separately with some models)/10 cm × 10 cm (4 inches × 4 inches) : Small embroidery frame (sold separately with some models)/2 cm × 6 cm (1 inch × 2-1/2 inches) Press to enlarge the image of the pattern.
	Preview key	

No.	Display	Explanation
	Key Name	
⑤		Press this key to rotate the pattern. Press to return the pattern to its original position.
	Rotate key	
⑥		Press this key to change the colors of the displayed pattern. Press or to select the thread brand. Press or to select the color you want to change. Press or touch the color on the color palette to choose a new color. To return to the original color, press .
	Thread palette key	
⑦		Press this key to delete the selected pattern (the pattern outlined by the red box).
	Delete key	
⑧		Press this key to display the font editing screen. (page 43)
	Font edit key	
⑨		Press this key to call up the embroidery settings screen. (page 44)
	Edit End key	
⑩		Press this key to save patterns to the machine's memory or USB flash drive. Patterns can also be transferred to a computer via wireless network connection. (page 47)
	Memory key	
⑪		When a combined pattern is selected, use this key to select a part of the pattern to edit. The selected pattern is outlined by the red box.
	Pattern select key	
⑫		Press this key to add another embroidery pattern to currently displayed pattern.
	Add key	
⑬		Press this key to make a horizontal mirror image of the selected pattern.
	Horizontal mirror image key	
⑭		Press this key to change thread density for some alphabet character and frame patterns.
	Thread density key	
⑮		Press this key to move the pattern. Use to move the pattern in the direction shown by the arrow. Press to center the pattern.
	Move key	

No.	Display	Explanation
	Key Name	
16	Size	Press this key to change the size of the pattern. : Enlarges the pattern proportionately. : Decreases the pattern proportionately. : Stretches the pattern horizontally. : Decreases the pattern horizontally. : Stretches the pattern vertically. : Decreases the pattern vertically. : Returns the pattern to its original size. : Changes the size of the character patterns.
	Size key	

Font editing screen

Font editing screen appears by pressing on the pattern editing screen.

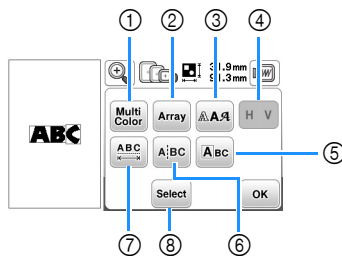

No.	Display	Explanation
	Key Name	
1	Multi Color	Press this key when you want to change the thread color, character by character in character embroidery. Since the machine stops at the end of each character, the upper thread is changed as you embroider. Press this key again to cancel setting.
	Multi color key	
2	Array	Press this key to change the configuration of a character pattern. When selecting an arc (), use and to change the degree of the arc. : Make the arc flatter. : Make the arc rounder. When selecting and , change to and . You can increase or decrease the incline. To arrange the spacing between the character patterns on the line, press .
	Array key	
3	Font key	Press this key to change the font of the selected characters. Depending on the font that was selected, it may not be possible to change the font.
4	Vertical/horizontal text key	Press this key to switch between text written vertically and horizontally. (Japanese font only)

No.	Display	Explanation
	Key Name	
5	A bc	Press this key to edit each character separately. When pressing , select the character by using to change the size. When pressing , select the character by using to change the font.
	Edit character key	
6	A B C	Press this key to split text between characters so that they can be edited separately. Use to select where the pattern is to be separated, and then press to separate it. Any pattern that is split cannot be recombined.
	Split text key	
7	ABC	Press this key to change the spacing of character patterns. Press to increase or decrease the character spacing. Press to return the pattern to its original appearance.
	Character spacing key	
8	Select	When a combined pattern is selected, use this key to select a part of the pattern to edit. The selected pattern is outlined by the red box. If the line feed key was used while entering text, single lines can be selected.
	Select key	

Editing Patterns (Embroidery Settings Screen)

When **Edit/End** is pressed in the editing screen, the embroidery settings screen appears. After editing the pattern, press **Embroidery** to continue to the embroidering screen.

Embroidery settings screen

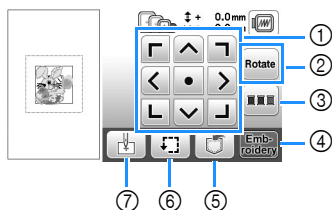

No.	Display	Explanation
	Key Name	
①		Press these keys to move the pattern in the direction shown by the arrow. (Press the center key to return the pattern to the center of the embroidery area.) (page 44)
	Move key	
②		Press this key to rotate the entire pattern. Press Reset to return the pattern to its original position.
	Rotate key	
③		Press this key to rearrange the stitching sequence for combined patterns.
④		Press this key to enter the embroidery screen.
	Embroidery key	
⑤		Press this key to save patterns to the machine's memory or USB flash drive. Patterns can also be transferred to a computer via wireless network connection. (page 47)
	Memory key	
⑥		Press this key to check the position of the pattern. (page 33)
	Trial key	
⑦		Press this key to move the needle start position to align the needle with the pattern position. (page 44)
	Starting point key	

Aligning the pattern and the needle position

Example: Aligning the lower left side of a pattern and the needle position

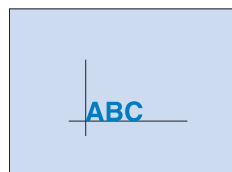

- 1 Mark the embroidery start position on the fabric, as shown.

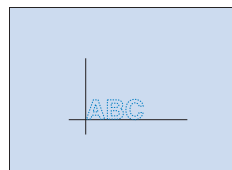

- 2 Press

- 3 Press and press **OK**.

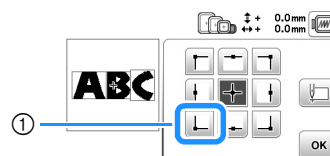

- ① Start position

→ The needle position moves to the bottom left corner of the pattern (the embroidery frame moves so that the needle is positioned correctly).

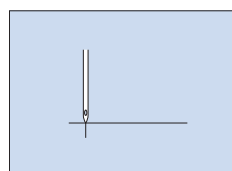
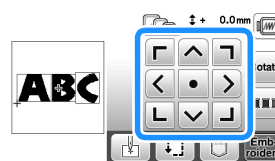

- 4 Use to align the needle and the mark on the fabric, press **Embroidery** and begin embroidering the pattern.



Embroidering linked characters

Follow the procedure described below to embroider linked characters in a single row when the entire pattern extends beyond the embroidery frame.

Example: Linking “DEF” to the characters “ABC” using embroidery frame 10 cm × 10 cm (4 inches × 4 inches) (sold separately with some models)

- 1 Select the character patterns for “ABC”, and then press **Set** and **Edit End**.
- 2 Press .
- 3 Press , and then press **OK**.

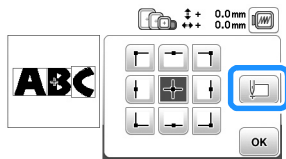

→ The needle is positioned in the lower-left corner of the pattern. The embroidery frame moves so that the needle is positioned correctly.



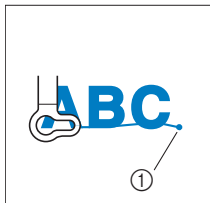

- 4 Press **Embroidery**.
- 5 Lower the embroidery foot and then press the “Start/Stop” button to begin embroidering.
- 6 After the characters are embroidered, and the threads are cut, remove the embroidery frame, and then press **OK** for [Finished embroidering].

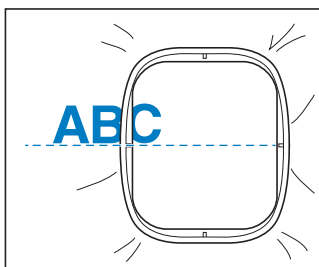

① End of the embroidering

- 7 Reposition the fabric in embroidery frame so that the right side of the letter “C” will be partially inside the embroidery frame; being careful so letters remain straight and level. Then reattach frame again so that the remaining characters (“DEF”) can be embroidered.



- 8 Press  to cancel the current character patterns.
- 9 Select the character patterns for “DEF”, and then press **Set** and **Edit End**.
- 10 Press .
- 11 Press , and then press **OK**.
→ The needle is positioned in the lower-left corner of the pattern. The embroidery frame moves so that the needle is positioned correctly.
- 12 Use  to align the needle with the end of the embroidering for the previous pattern.

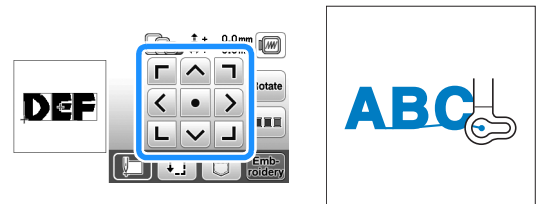

- 13 Press **Embroidery**.
- 14 Lower the embroidery foot and press the “Start/Stop” button to begin embroidering the remaining character patterns.



Thread color sorting

This function allows you to embroider while replacing the thread spool a minimal number of times.

Before starting to embroider, press  in the embroidery settings screen to rearrange the embroidery order and sort it by thread colors.

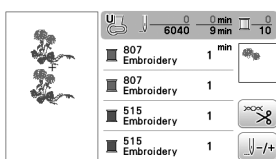
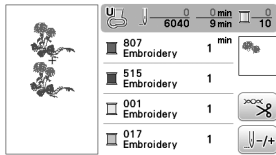

1 Press .

* Press  again to check the sorted thread colors.

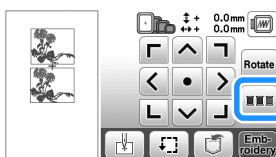

The embroidery color order is rearranged and sorted by thread colors.

Press  again in the embroidery settings screen to cancel color sorting and embroider with the original embroidery color order.

Note

- This function does not work on overlapping designs.

Using the Memory Function

Embroidery data precautions

CAUTION

- When using embroidery data other than our original patterns, the thread or needle may break when embroidering with a stitch density that is too fine or when embroidering three or more overlapping stitches. In that case, use one of our original data design systems to edit the embroidery data.

Types of embroidery data that can be used

Only .pes, .phc, .pen, and .dst embroidery data files can be used with this machine. Attempting to use data other than the listed type may cause the machine to malfunction.

Embroidery pattern size

This machine is compatible with embroidery patterns up to a maximum of 26 cm × 16 cm (approx. 10-1/4 inches × 6-1/4 inches).

USB flash drive

Some USB flash drives may not be usable with this machine. Please visit our website "<http://s.brother/cphan/>" for more details.

Precautions on using the computer to create and save data

We recommend using the 26 letters of the alphabet (uppercase and lowercase), the numbers 0 through 9, "-", and "_" for the name of the file/folder.

Tajima (.dst) embroidery data

- .dst data is displayed in the pattern list screen by file name (the actual thumbnail image cannot be displayed).
- Since Tajima (.dst) data does not contain specific thread color information, it is displayed with our default thread color sequence. Check the preview and change the thread colors as desired.

Saving embroidery patterns

You can save embroidery patterns that you have customized in the machine's memory, or on a USB flash drive. You can also transfer the patterns to your computer via wireless network.

Note

- Do not turn the main power to OFF while the [Saving...] screen is displayed. You will lose the pattern you are saving.

- Press  when the pattern you want to save is in the pattern editing screen or embroidery settings screen.

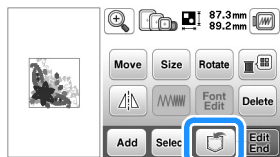

- When saving the embroidery pattern in a USB flash drive, insert the USB flash drive into the USB port on the machine.

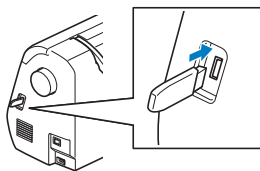

- Select the destination to start saving.

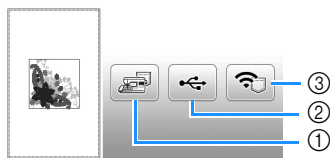

- Save to the machine's memory.
- Save to the USB flash drive. The pattern is saved in a folder labeled "bPocket".
- Temporarily save to the wireless function pocket. For the detailed procedure, refer to the manual for PE-DESIGN (version 11 or later).
 - * Embroidery patterns which were saved to the wireless function pocket will be deleted from the pocket when turning the machine off. Import the embroidery patterns to PE-DESIGN (version 11 or later) before turning the machine off.

Retrieving embroidery patterns

Retrieve embroidery patterns saved in the machine's memory, or on a USB flash drive, or transferred via wireless network.

- When retrieving the embroidery patterns from a USB flash drive, insert the USB flash drive into the USB port on the machine.

To retrieve embroidery patterns via wireless network, use PE-DESIGN (version 11 or later) or Design Database Transfer to transfer the patterns in advance. For details on transferring embroidery patterns, refer to the manual for PE-DESIGN or Design Database Transfer.

- Press .

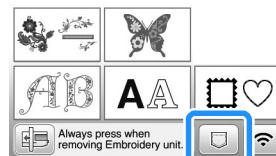

- Press the desired destination, and then select the desired embroidery pattern.



- Retrieve from the machine's memory.
- Retrieve from a USB flash drive.
- Retrieve embroidery patterns uploaded to the wireless function pocket via wireless network. For the detailed procedure, refer to the manual for PE-DESIGN (version 11 or later) or Design Database Transfer.
 - * Embroidery patterns which were uploaded via wireless network will be deleted from the machine when turning the machine off. Save patterns to the machine memory if necessary. (page 47)

Memo

- If the embroidery pattern to be retrieved is in a folder of the USB flash drive, press the key for that folder. Press  to return to the previous screen.

4 Press .





 **Memo**

- When you press , the selected embroidery pattern will be deleted permanently.
- When saving a retrieved pattern, press the following keys.

1. Press .



2. Press the key for the desired destination.

-  : Saves to the machine.
-  : Saves to the USB flash drive.
-  : Temporarily saves to the wireless function pocket.

Chapter 3 APPENDIX

Care and Maintenance

⚠ CAUTION

- Unplug the power cord before cleaning the machine, otherwise injuries or an electric shock may occur.

Cleaning the LCD

If the surface of the LCD is dirty, lightly wipe it with a soft dry cloth.

Cleaning the machine surface

When wiping dirt off the machine, firmly wring a soft cloth soaked in (lukewarm) water.

After cleaning the machine, dry it with a soft, dry cloth.

Restrictions on oiling

In order to prevent damaging this machine, it must not be oiled by the user.

This machine was manufactured with the necessary amount of oil applied to ensure correct operation, making periodic oiling unnecessary.

If problems occur, such as difficulty turning the handwheel or an unusual noise, immediately stop using the machine, and contact your authorized Brother dealer or the nearest Brother authorized service center.

Precautions on storing the machine

Do not store the machine in any of the locations described below, otherwise damage to the machine may result, for example, rust caused by condensation.

- Exposed to extremely high temperatures
- Exposed to extremely low temperatures
- Exposed to extreme temperature changes
- Exposed to high humidity or steam
- Near a flame, heater or air conditioner
- Outdoors or exposed to direct sunlight
- Exposed to extremely dusty or oily environments

💡 Note

- In order to extend the life of this machine, periodically turn it on and use it. Storing this machine for an extended period of time without using it may reduce its efficiency.

Cleaning the race

Stitching performance will suffer if lint and dust collects in the bobbin case, therefore, it should be cleaned regularly.

- 1 Press  (Needle position button) to raise the needle.
- 2 Turn off the machine.
- 3 Unplug the power cord from the power supply jack on the right side of the machine.
- 4 Remove the needle and embroidery foot.
 - For details, refer to "Replacing the Needle" on page 23 and "Replacing the embroidery foot" on page 50.
- 5 Remove the embroidery unit.
- 6 Remove the bobbin cover.
- 7 Remove the needle plate cover.

■ If there is a screw in the needle plate cover

- 1 Use the L-shaped (or disc-shaped) screwdriver to remove the screw in the needle plate cover.

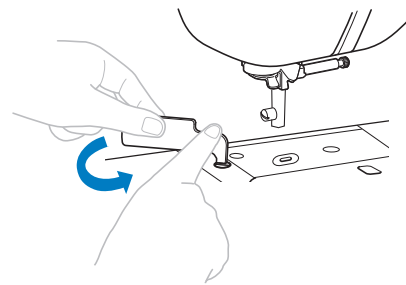

- 2 Grasp both sides of the needle plate cover, and then slide it toward you.

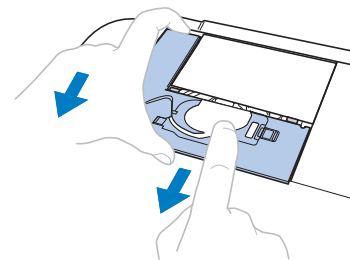

■ If there is no screw in the needle plate cover

- 1 Grasp both sides of the needle plate cover, and then slide it toward you.

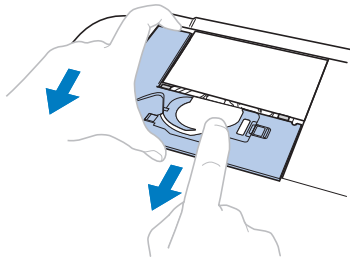

- 8 Grasp the bobbin case, and then pull it out.

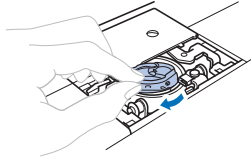

- 9 Use the cleaning brush or a vacuum cleaner to remove any lint and dust from the race and bobbin thread sensor and the surrounding area.

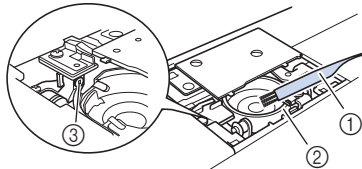

- ① Cleaning brush
- ② Race
- ③ Bobbin thread sensor

Note

- Do not apply oil to the bobbin case.

- 10 Insert the bobbin case so that the ▲ mark on the bobbin case aligns with the ● mark on the machine.

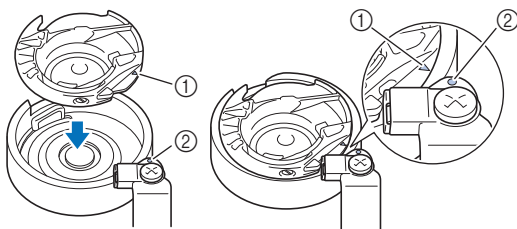

- Align the ▲ and ● marks.

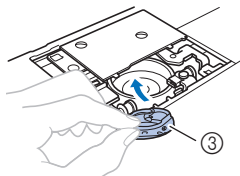

- ① ▲ mark
- ② ● mark
- ③ Bobbin case

- Make sure that the indicated points are aligned before installing the bobbin case.

- 11 Insert the tabs on the needle plate cover into the needle plate, and then slide the cover back on. Reattach the bobbin cover.

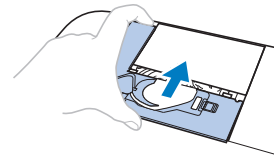

⚠ CAUTION

- Never use a bobbin case that is scratched or has a burr on it. Otherwise the upper thread may become tangled, the needle may break or stitching performance may suffer. For a new bobbin case, contact your nearest Brother authorized service center.
- Be sure that the bobbin case is correctly installed, otherwise the needle may break.

Touch panel is malfunctioning

If the screen does not respond correctly when you touch a key (the machine does not perform the operation or performs a different operation), follow the steps below to make the proper adjustments.

- 1 Holding your finger on the screen, turn the main power switch to OFF and back to ON.



→ The touch panel adjustment screen is displayed.

- 2 Lightly touch the center of each +, in order from 1 to 5.

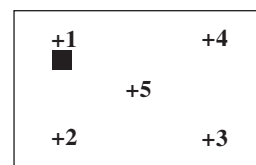



- 3 Turn the main power to OFF, then turn it back to ON.

Replacing the embroidery foot

⚠ CAUTION

- Only use embroidery feet designed specifically for this machine. Use of any other embroidery foot may result in injuries or damage to the machine.

- 1 Press \oplus (Needle position button) once or twice to raise the needle.

- 2 Press .
- When the message [OK to automatically lower the presser foot?] appears on the LCD screen, press  to continue.
- The screen changes, and all keys and operation buttons are locked (except .

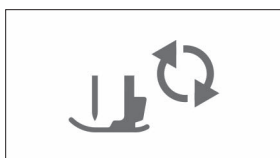

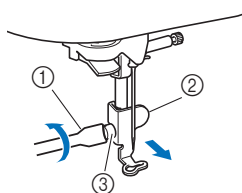

- 3 Raise the presser foot lever.
- 4 Use the included screwdriver to loosen the embroidery foot screw, and then remove the embroidery foot.

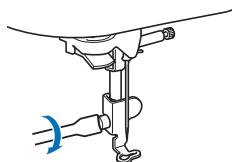

- ① Screwdriver
- ② Embroidery foot
- ③ Embroidery foot screw

- 5 Hold the embroidery foot in place with your right hand, and then use the included screwdriver to securely tighten the embroidery foot screw.



- 6 Slowly lower the presser foot lever.
- 7 Raise the presser foot lever to check that the embroidery foot is securely attached.
- 8 Press  to unlock all keys and buttons.

Troubleshooting

If the machine stops operating correctly, check the following possible problems before requesting service. You can solve most problems by yourself. If you need additional help, Brother support website offers the latest FAQs and troubleshooting tips. Visit us at “ <http://s.brother/cphan/> ”.

If the problem persists, contact your Brother dealer or the nearest Brother authorized service center.

List of symptoms

Check the following possible problems before requesting service. If the reference page is “*”, contact your authorized Brother dealer or the nearest Brother authorized service center.

Getting ready

Symptom, Cause/solution	Reference
Cannot thread the needle.	
Needle is not in the correct position. <ul style="list-style-type: none"> Press the “Needle position” button to raise the needle. 	10
Needle is installed incorrectly.	23
Needle is turned, bent or the point is dull.	23
Upper threading is incorrect. The needle threader lever is not lowered until it clicks.	20
The needle threader hook is bent and does not pass through the eye of the needle.	*
The needle threader lever cannot be moved or returned to its original position.	*
Cannot lower the presser foot with the presser foot lever.	
Presser foot was raised using the “Presser foot lifter” button.	10
Bobbin thread does not wind neatly on the bobbin.	
The thread is not passed through the bobbin winding thread guide correctly.	16
The thread that was pulled out from the bobbin winding thread guide was incorrectly wound onto the bobbin.	18
The empty bobbin was not set on the pin properly.	16
While winding the bobbin, the bobbin thread was wound below the bobbin winder seat.	
The thread was incorrectly passed under the pretension disk on the bobbin winding thread guide. <ul style="list-style-type: none"> Remove any entangled thread, and then wind the bobbin. 	16
The bobbin thread cannot be pulled up.	
Bobbin is set incorrectly.	19
Nothing appears in the LCD.	
Main power switch is not turned on.	11
The plug of the power cord is not inserted into an electrical outlet.	11
The LCD screen is fogged up.	

Symptom, Cause/solution	Reference
Condensation has formed on the LCD screen. • After a while, the cloudiness will disappear.	–
The operation keys do not respond, or the key response is too sensitive.	
A glove is worn when the keys are pressed. The keys are pressed with a fingernail. A non-electrostatic touch pen is being used. The sensitivity of the operation keys is not set for the user.	10, 13
The sewing light does not come on.	
[Light] is set to [OFF] in the settings screen.	12
Embroidery unit does not operate.	
Embroidery unit is not attached correctly.	25
Embroidery frame was attached before the unit was initialized.	25
Cannot retrieve an embroidery pattern via wireless network.	
Embroidery patterns unavailable for this machine cannot be retrieved. • Check the embroidery data and the message displayed on the application.	–

■ While embroidering

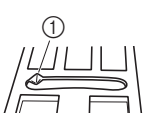
Symptom, Cause/solution	Reference
Machine does not operate.	
“Start/Stop” button was not pressed.	34
The bobbin winder shaft is pushed to the right.	16
There is no pattern selected.	31
Presser foot is not lowered.	34
Frame-securing lever was not lowered. • Lower frame-securing lever after installing embroidery frame.	29
Needle breaks.	
Needle is installed incorrectly.	23
Needle clamp screw is not tightened.	23
Needle is turned or bent.	23
Using improper needle or thread for the selected fabric.	23
Upper thread tension is too tight.	37
Spool of thread is set incorrectly.	16
There are scratches around the opening in the needle plate. * There is a notch on the left side of the opening in the needle plate. This is not a scratch.	*
	
There are scratches around the opening in the presser foot.	*
There are scratches on the bobbin case.	*
A bobbin designed specifically for this machine is not used.	16
Upper threading is incorrect.	20

Symptom, Cause/solution	Reference
Bobbin is set incorrectly.	19
Embroidery foot is attached incorrectly.	50
Stabilizer is not attached to fabric being embroidered.	27
Bobbin thread is incorrectly wound.	16
Upper thread breaks.	
Machine is not threaded correctly (used the wrong spool cap, spool cap is loose, the thread did not catch the needle bar threader, etc.).	20
Knotted or tangled thread is being used.	–
Upper thread tension is too tight.	37
Thread is tangled.	20
Needle is turned, bent or the point is dull.	23
Needle is installed incorrectly.	23
There are scratches near the hole in the embroidery foot.	50, *
There are scratches on the bobbin case.	*
Using improper needle or thread for the selected fabric.	23
A bobbin designed specifically for this machine is not being used.	16
The thread is tangled on the wrong side of the fabric.	
Upper threading is incorrect.	20
Using improper needle or thread for the selected fabric.	23
The upper thread is too tight.	
The bobbin thread is incorrectly installed.	19
Bobbin thread breaks.	
Bobbin is set incorrectly.	19
Bobbin thread is incorrectly wound.	16
A scratched bobbin is being used.	19
Thread is tangled.	20
A bobbin designed specifically for this machine is not being used.	16
Fabric puckers.	
There is a mistake in the upper or bobbin threading.	16, 20
Spool of thread is set incorrectly.	17
Using improper needle or thread for the selected fabric.	23
Needle is turned, bent or the point is dull.	23
Skipped stitches	
Machine is threaded incorrectly.	16, 20
Needle is turned, bent or the point is dull.	23
Needle is installed incorrectly.	23
Dust or lint has collected under the needle plate.	49
Not embroidering	
Needle is turned, bent or the point is dull.	23
Bobbin is set incorrectly.	19
Upper threading is incorrect.	20

Symptom, Cause/solution	Reference
High-pitched sound while embroidering	
Pieces of thread are caught in the race.	49
Upper threading is incorrect.	20
A bobbin designed specifically for this machine is not being used.	16
There are needle holes or friction scratches in the bobbin case.	*
The needle contacts the needle plate.	
The needle clamp screw is loose.	23
Needle is turned, bent or the point is dull.	23
The handwheel does not turn smoothly.	
Thread is tangled in the bobbin case.	*

■ After embroidering



Symptom, Cause/solution	Reference
Thread tension is incorrect.	
Upper threading is incorrect.	20
Bobbin is set incorrectly.	19
Using improper needle or thread for the selected fabric.	23
Thread tension is set incorrectly.	37
Bobbin thread is incorrectly wound.	16
Needle is turned, bent or the point is dull.	23
A bobbin designed specifically for this machine is not used.	16
Embroidery pattern does not embroider correctly.	
Thread is twisted.	20
Thread tension is set incorrectly.	37
Fabric was not inserted into the frame correctly (fabric was loose, etc.).	28
Stabilizing material was not attached. <ul style="list-style-type: none"> Always use stabilizing material, especially with stretch fabrics, lightweight fabrics, fabrics with a coarse weave, or fabrics that often cause pattern shrinkage. See your authorized Brother dealer for the proper stabilizer. 	27
There was an object placed near the machine, and the carriage or embroidery frame hit the object during embroidering.	25
Material coming out of the embroidery frame is causing problems. <ul style="list-style-type: none"> Stretch the fabric on the frame once again so that the material coming out of the embroidery frame does not cause problems, rotate the pattern and embroider. 	27
A heavy fabric is being embroidered, and the fabric is hanging off the table. <ul style="list-style-type: none"> If embroidery is done with the fabric hanging off the table, the embroidery unit movement will be impaired. Support the fabric while embroidering. 	34
Fabric is snagged or caught on something. <ul style="list-style-type: none"> Stop the machine and place the fabric so that it does not get caught or snagged. 	-

Symptom, Cause/solution	Reference
The carriage was moved while the embroidery frame was being removed or attached during embroidery. <ul style="list-style-type: none"> If the carriage is moved during the process, the pattern may be misaligned. Be careful when removing or attaching the embroidery frame. 	29
Stabilizer is incorrectly attached, for example, it is smaller than the embroidery frame.	27
Embroidery pattern does not embroider in a particular position.	
Fabric isn't positioned with the proper position in the embroidery frame. <ul style="list-style-type: none"> Use the embroidery sheet. 	29
Loops appear on the surface of the fabric when embroidering.	
The thread tension is incorrectly set.	37
Embroidery bobbin thread intended for use with this machine is not being used.	27

Error messages

When erroneous operations are performed messages and advice on operation will be displayed on the LCD. Follow what is displayed. If you press  or do the operation correctly while the error message is displayed, the message disappears.

	Error messages	Cause/solution
1	A malfunction occurred. Turn the machine off, then on again.	This message is displayed if a malfunction occurs. Turn the machine off, then back on again. If this message continues to appear, please contact your authorized Brother dealer or the nearest Brother authorized service center.
2	Cannot change the configuration of the characters.	This message is displayed when there are too many characters and the curved character configuration is impossible.
3	Cannot change the font since some letters are not included to the selected font.	This message appears when the font of the embroidery character pattern is changed to one that does not include characters used in the pattern.
4	Cannot recognize the data for the selected pattern. The data may be corrupted. Please turn off the power and turn on again.	This message appears when you try to retrieve pattern data that is invalid. Since any of the following may be the cause, check the pattern data. <ul style="list-style-type: none"> The pattern data is damaged. The data that you tried to retrieve was created using another manufacturer's data design system. Turn the machine off, then on again to return it to its normal condition.
5	Check and rethread the upper thread.	This message is displayed when the upper thread is broken or not threaded correctly, and the "Start/Stop" button, etc. is pressed.
6	Data volume is too large for this pattern.	This message is displayed when the patterns you are editing take up too much memory, or if you are editing too many patterns for the memory.
7	Lower the presser foot lever.	This message is displayed when a button, such as the "Start/Stop" button, was pressed while the presser foot was raised.
8	Not enough available memory to save.	This message is displayed when the memory is full and the pattern cannot be saved.
9	Not enough available memory to save the pattern. Delete another pattern?	This message is displayed when the memory is full and the pattern cannot be saved. Press  and delete a previously saved pattern to save the current one. Press  to return to the original screen without saving.
10	OK to recall and resume previous memory?	This message appears if the machine is turned off while embroidering, then turned on again. Press  to return the machine to the condition (pattern position and number of stitches) when it was turned off. Follow the procedure described in "If the thread breaks during embroidering" on page 36 to align the needle position and embroider the remainder of the pattern.
11	Pattern extends to the outside of embroidery frame.	This message appears when the embroidery character pattern is edited, for example, rotated, so that it no longer fits within the embroidery frame.
12	Pattern extends to the outside of embroidery frame. Add no additional characters.	This message appears when the embroidery character pattern is edited by adding a line feed so that it no longer fits within the embroidery frame.
13	Pattern extends to the outside of embroidery frame. This function cannot be used at this time.	This message appears when the embroidery character pattern is resized or switched between written vertically/horizontally so that it is too large for the embroidery frame.
14	Preventive maintenance is recommended.	Once this message appears, it is recommended to take your machine to an authorized Brother dealer or nearest Brother authorized service center for a regular maintenance check. Although this message will disappear and the machine will continue to function once you press  , the message will display several more times until the appropriate maintenance is performed.

	Error messages	Cause/solution													
15	The authentication and encryption methods used by the selected wireless LAN access point/router are not supported by your machine.	<p>The authentication/encryption methods used by the selected wireless access point/router are not supported by your machine.</p> <p>For infrastructure mode, change the authentication and encryption methods of the wireless access point/router. Your machine supports the following authentication methods:</p> <table border="1" data-bbox="767 376 1441 640"> <thead> <tr> <th>Authentication method</th> <th>Encryption method</th> </tr> </thead> <tbody> <tr> <td rowspan="2">WPA-Personal</td> <td>TKIP</td> </tr> <tr> <td>AES</td> </tr> <tr> <td rowspan="2">WPA2-Personal</td> <td>TKIP</td> </tr> <tr> <td>AES</td> </tr> <tr> <td rowspan="2">Open</td> <td>WEP</td> </tr> <tr> <td>None (without encryption)</td> </tr> <tr> <td>Shared key</td> <td>WEP</td> </tr> </tbody> </table> <p>If your problem is not solved, the SSID or network settings you entered may be incorrect. Reconfirm the wireless network settings. (page 14) Refer to “How can I find the wireless security information (SSID and network key)” on page 56.</p>	Authentication method	Encryption method	WPA-Personal	TKIP	AES	WPA2-Personal	TKIP	AES	Open	WEP	None (without encryption)	Shared key	WEP
Authentication method	Encryption method														
WPA-Personal	TKIP														
	AES														
WPA2-Personal	TKIP														
	AES														
Open	WEP														
	None (without encryption)														
Shared key	WEP														
16	The bobbin thread is almost empty.	<p>This message is displayed when the bobbin thread is running out. Although a few stitches can be embroidered when the “Start/Stop” button is pressed, replace with a wound bobbin immediately.</p> <p>When embroidering, press  (Thread cutter button) to cut the threads, raise the presser foot, remove the embroidery frame, and then replace the bobbin with one wound with plenty of embroidery bobbin thread.</p>													
17	The bobbin winder safety device has activated. Is the thread tangled?	This message is displayed when the bobbin is being wound, and the motor locks because the thread is tangled, etc.													
18	 The carriage of the embroidery unit will move. Keep your hands etc. away from the carriage.	This message appears before embroidery unit moves.													
19	The machine is still trying to connect to your wireless network.	The machine is still trying to connect to your wireless network. Please wait a few minutes, and then check the WLAN status.													
20	 The safety device has been activated. Is the thread tangled? Is the needle bent?	This message is displayed when the motor locks due to tangled thread or for other reasons related to thread delivery.													
21	The SSID and Network Key are incorrect.	<p>The security information (SSID/network key (password)) is incorrect. Reconfirm the SSID and security information (network key (password)). (page 14) Refer to “How can I find the wireless security information (SSID and network key)” on page 56.</p>													
22	The wireless LAN access point/router cannot be detected.	<p>The wireless access point/router cannot be detected.</p> <ol style="list-style-type: none"> Check the following 4 points. <ul style="list-style-type: none"> - Make sure that the wireless access point/router is powered on. - Move your machine to an area where no items can obstruct the wireless network signal, such as metal doors or walls, or closer to the wireless access point/router. - Temporarily place your machine within about 1 m (3.3 feet) from the wireless access point when you are configuring the wireless settings. - If your wireless access point/router is using MAC address filtering, confirm the MAC address of this machine is allowed in the filter. If you manually entered the SSID and security information (SSID/authentication method/encryption method/network key (password)), the information may be incorrect. Reconfirm the SSID and security information and re-enter the correct information as necessary. (page 14) Refer to “How can I find the wireless security information (SSID and network key)” on page 56. 													

	Error messages	Cause/solution
23	The wireless security information (Authentication method, Encryption method, Network Key) is incorrect.	The wireless security information (authentication method/encryption method/network key (password)) is incorrect. Refer to the table for the [The authentication and encryption methods used by the selected wireless LAN access point/router are not supported by your machine.] error message, and reconfirm the wireless security information (authentication method/encryption method/network key (password)). (page 14) Refer to “How can I find the wireless security information (SSID and network key)” on page 56.
24	The wireless setting is not activated.	The wireless network setting is not activated. Activate the wireless network. (page 14)
25	This pattern cannot be used.	This message appears when you try to retrieve a pattern that cannot be used with this machine.
26	This USB media cannot be used.	This message is displayed when you try to use incompatible media.
27	USB media is not loaded. Load USB media.	This message is displayed when you try to recall or save a pattern while no USB flash drive is loaded.
28	F**	If error message [F**] appears in the LCD while the machine is being used, the machine may be malfunctioning. Contact your authorized Brother dealer or the nearest Brother authorized service center.

How can I find the wireless security information (SSID and network key)

- 1) You should see the documentation provided with your wireless access point/router.
- 2) The default SSID (wireless network name) could be the manufacturer’s name or the model name.
- 3) If you do not know the security information, please consult the router manufacturer, your system administrator, or internet provider.
- 4) Some Wireless SSIDs and network keys (passwords) are case (upper case and lower case) sensitive. Please properly record your information.

- * The network key may also be described as a password, security key or encryption key.
- * If the wireless access point/router is not broadcasting the SSID, the SSID will not automatically be detected. You will have to manually enter the SSID.

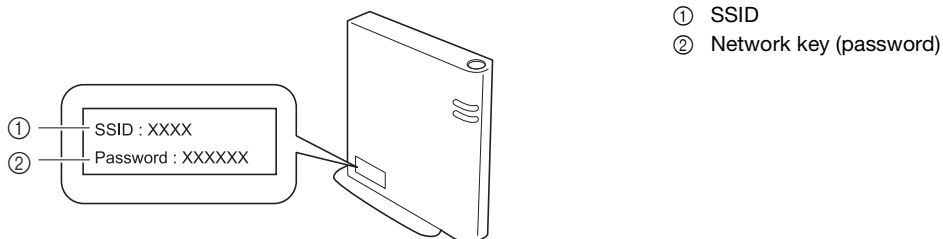

Operation beeps

If a correct operation is performed, the machine beeps one time.

If an incorrect operation is performed, the machine beeps two or four times.

If the machine locks up, for example, because the thread is tangled, the machine continues to beep for four seconds, and then the machine automatically stops. Be sure to check for the cause of the error, and correct it before continuing to embroider.

Specifications

Item	Specification
Dimensions of machine	Approx. 480 mm (W) × 250 mm (D) × 300 mm (H) (Approx. 18-7/8 inches (W) × 9-7/8 inches (D) × 11-7/8 inches (H))
Weight of machine	For 888-G60: Approx. 8.6 kg (Approx. 20 lb) For 888-G70/G72: Approx. 8.7 kg (Approx. 20 lb)
Dimensions of machine with embroidery unit attached	Approx. 693 mm (W) × 421 mm (D) × 300 mm (H) (Approx. 27-3/8 inches (W) × 16-5/8 inches (D) × 11-7/8 inches (H))
Weight of machine with embroidery unit attached	For 888-G60: Approx. 12.1 kg (Approx. 27 lb) For 888-G70/G72: Approx. 12.2 kg (Approx. 27 lb)
Sewing speed	70 to 850 stitches per minute

* Please be aware that some specifications may change without notice.

Updating Your Machine's Software

The machine's software can be updated using USB flash drive.

When an update program is available on the Brother support website at "<http://s.brother/cphan>", please download the file(s) following the instructions on the website and steps listed below.

Note

- When using USB flash drive to update the software, check that no data other than the update file is saved on the USB flash drive being used before starting to update.

Memo

- When the machine's software is updated, saved embroidery patterns will not be erased.

When using the wireless function, the update mark is displayed on the wireless LAN key.

: Updated software is available on our website. Update the software.

: No updated software is available.

Version information can be checked from the settings screen. (page 13)

- 1 Turn on the machine while pressing and holding  (Presser foot lifter button).

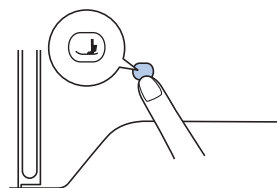

→ The following screen appears.

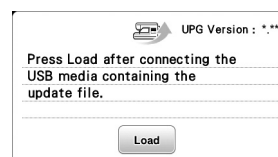

- 2 Insert the USB flash drive into the USB port on the machine.

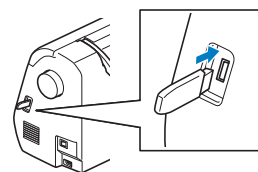

Note

- Save only the update file on the USB media.

- 3 Press .

- Do not turn off the machine during the update.

→ When updating is finished, the completion message appears.

- 4 Remove the USB flash drive, and turn the machine off and on again.

Index

A

Aligning the position	44
Appliqué	39, 40
Automatic thread cutting function	38

B

Bobbin	16
runs out of thread	35
Bobbin case	50
Bobbin installation	19
Bobbin thread	16, 27
Bobbin winding	16
Bobbin winding thread guide	16

C

Character spacing	43
Cleaning	49
Cut/Tension key	37

E

Embroidery	25
Embroidery frames	28, 29
removing	30
Embroidery sheet	29
End Color Trim	38
Error messages	54

F

Fabric	27
Feed dogs	9
File format	46
Font	32

I

Included accessories	10
----------------------------	----

J

Jump Stitch Trim	39
------------------------	----

L

Language	12
LCD	10, 12
Light	12

M

Maintenance	49
Memory	46
Metallic thread	17, 22
Mirroring	42

N

Needle	23
Needle plate	9
Needle plate cover	9, 49
Needle position	12
Needle threader	22

O

Operation beep	12, 56
----------------------	--------

P

Power supply	11
Presser foot replacement	50

R

Race	50
Replacing presser foot	50
Retrieving	47
Rotate	42, 44

S

Saving	47
Size	43
Split embroidery patterns	41
Spool cap	17
Spool net	17
Stabilizer	28

T

Terms of Use	5
Thread	27
Thread color display	35
Thread color sorting	46
Thread density	42
Thread tension	37
Thread trimming function	39
Troubleshooting	51

U

Updating	57
Upper thread	20, 27
USB	46

W

Wireless LAN	14
--------------------	----













Various optional accessories are available to be purchased separately.

Visit our website <http://s.brother/cohan/>.



Please visit us at <http://s.brother/cphan/> where you can get product support and answers to frequently asked questions (FAQs).



Be sure to install the latest software.

A variety of functional improvements are being performed in the latest version.



Brother SupportCenter is a mobile app that provides the support information for your Brother product.

Visit the Google Play™ or App Store to download.



Google Play™



App Store

This machine is approved for use in the country of purchase only. Local Brother companies or their dealers will only support machines purchased in their own countries.



Design Database Transfer is a dedicated Windows application for wirelessly transferring embroidery data from a computer to the machine. This application can also be used to view and manage embroidery data.

Visit us at <http://s.brother/cahkb/> to download the application.

English
888-G60/G70/G72



D01W30-001